

LEIF MEJLBRO

**TOPOLOGICAL AND METRIC SPACES,
BANACH SPACES...**

**...AND BOUNDED OPERATORS - FUNCTIONAL ANALYSIS
EXAMPLES C-2**

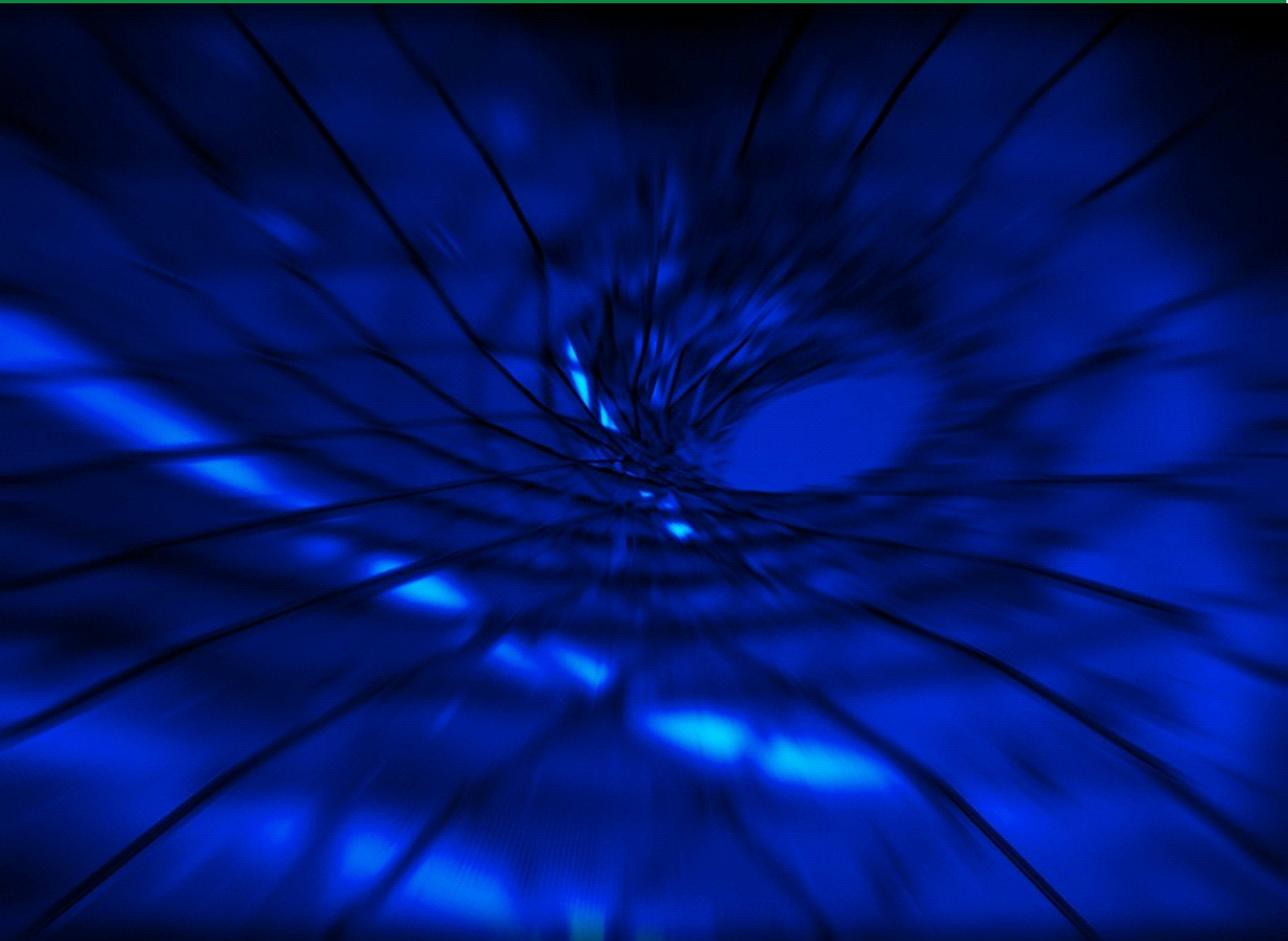

DOWNLOAD FREE TEXTBOOKS AT
BOOKBOON.COM
NO REGISTRATION NEEDED

Leif Mejlbro

Topological and Metric Spaces,
Banach Spaces and Bounded Operators

Topological and Metric Spaces, Banach Spaces and Bounded Operators

© 2009 Leif Mejlbro & Ventus Publishing ApS

ISBN 978-87-7681-531-8

Disclaimer: The texts of the advertisements are the sole responsibility of Ventus Publishing, no endorsement of them by the author is either stated or implied.

Contents

	Introduction	5
1	Topological and metric spaces	6
1.1	Weierstra 's approximation theorem	6
1.2	Topological and metric spaces	9
1.3	Contractions	26
1.4	Simple integral equations	38
2	Banach spaces	45
2.1	Simple vector spaces	45
2.2	Normed spaces	49
2.3	Banach spaces	62
2.4	The Lebesgue integral	70
3	Bounded operators	82
	Index	96

Please click the advert

WHAT'S MISSING IN THIS EQUATION?

You could be one of our future talents

MAERSK INTERNATIONAL TECHNOLOGY & SCIENCE PROGRAMME

Are you about to graduate as an **engineer** or **geoscientist**? Or have you already graduated?
If so, there may be an exciting future for you with A.P. Moller - Maersk.



MAERSK

www.maersk.com/mitas

Introduction

This is the second volume containing examples from FUNCTIONAL ANALYSIS. The topics here are limited to *Topological and metric spaces*, *Banach spaces* and *Bounded operators*.

Unfortunately errors cannot be avoided in a first edition of a work of this type. However, the author has tried to put them on a minimum, hoping that the reader will meet with sympathy the errors which do occur in the text.

Leif Mejlbro
24th November 2009

1 Topological and metric spaces

1.1 Weierstraß's approximation theorem

Example 1.1 Let $\varphi \in C^1([0, 1])$. It follows from Weierstraß's approximation theorem that $B_{n,\varphi}(\theta)$ converges uniformly towards $\varphi(\theta)$ and that $B_{n,\varphi'}(\theta)$ converges uniformly towards $\varphi'(\theta)$ on $[0, 1]$.

Prove that $B'_{n,\varphi}(\theta) \rightarrow \varphi'(\theta)$ uniformly on $[0, 1]$.

HINT: First prove that $B'_{n,\varphi}(\theta) - B_{n-1,\varphi'}(\theta)$ converges uniformly towards 0 on $[0, 1]$.

Next prove that if $\varphi \in C^\infty([0, 1])$, then we have for every $k \in \mathbb{N}$ that $B_{n,\varphi}^{(k)}(\theta) \rightarrow \varphi^{(k)}(\theta)$ uniformly on $[0, 1]$.

NOTATION. We use here the notation

$$B_{n,\varphi}(\theta) = \sum_{k=0}^n \varphi\left(\frac{k}{n}\right) \cdot \binom{n}{k} \cdot \theta^k (1-\theta)^{n-k}$$

for the so-called *Bernstein polynomials*. \diamond

First write

$$\begin{aligned} B'_{n,\varphi}(\theta) - B_{n-1,\varphi'}(\theta) &= \sum_{k=0}^n \varphi\left(\frac{k}{n}\right) \cdot \binom{n}{k} \cdot \frac{d}{d\theta} \{\theta^k (1-\theta)^{n-k}\} \\ &\quad - \sum_{k=0}^{n-1} \varphi'\left(\frac{k}{n-1}\right) \cdot \binom{n-1}{k} \cdot \theta^k (1-\theta)^{n-1-k}. \end{aligned}$$

Please click the advert

CHALLENGE YOURSELF

WWW.STUDYINSWEDEN.SE

Today's job market values ambitious, innovative, perceptive team players. Swedish universities foster these qualities through a forward-thinking culture where you're close to the latest ideas and global trends.

Si.
Swedish Institute

Whatever your career goals may be, studying in Sweden will give you valuable skills and a competitive advantage for your future. www.studyinsweden.se

Here

$$\frac{d}{d\theta}\{\theta^k(1-\theta)^{n-k}\} = \begin{cases} n\theta^{n-1}, & \text{for } k = n, \\ k \cdot \theta^{k-1}(1-\theta)^{n-k} - (n-k)\theta^k(1-\theta)^{n-1-k}, & \text{for } 0 < k < n, \\ -n(1-\theta)^{n-1}, & \text{for } k = 0. \end{cases}$$

For $0 < k < n$ we perform the calculation

$$\begin{aligned} \binom{n}{k} \frac{d}{d\theta}\{\theta^k(1-\theta)^{n-k}\} &= \frac{n!}{k!(n-k)!} \{k\theta^{k-1}(1-\theta)^{n-k} - (n-k)\theta^k(1-\theta)^{n-1-k}\} \\ &= \frac{n!}{(k-1)!(n-k)!} \theta^{k-1}(1-\theta)^{n-k} - \frac{n!}{k!(n-k-1)!} \theta^k(1-\theta)^{n-1-k} \\ &= n \binom{n-1}{k-1} \theta^{k-1}(1-\theta)^{n-k} - n \binom{n-1}{k} \theta^k(1-\theta)^{n-1-k}. \end{aligned}$$

Hence

$$\begin{aligned} B'_{n,\varphi}(\theta) &= \sum_{k=0}^n \varphi\left(\frac{k}{n}\right) \cdot \binom{n}{k} \cdot \frac{d}{d\theta}\{\theta^k(1-\theta)^{n-k}\} \\ &= \varphi(0) \cdot \{-n(1-\theta)^{n-1}\} + \varphi(1) \cdot n\theta^{n-1} + n \sum_{k=1}^{n-1} \varphi\left(\frac{k}{n}\right) \cdot \binom{n-1}{k-1} \theta^{k-1}(1-\theta)^{n-k} \\ &\quad - n \sum_{k=1}^{n-1} \varphi\left(\frac{k}{n}\right) \cdot \binom{n-1}{k} \theta^k(1-\theta)^{n-1-k} \\ &= n \{\varphi(1) \cdot \theta^{n-1} - \varphi(0) \cdot (1-\theta)^{n-1}\} + n \sum_{k=0}^{n-2} \varphi\left(\frac{k+1}{n}\right) \cdot \binom{n-1}{k} \theta^k(1-\theta)^{n-1-k} \\ &\quad - n \sum_{k=1}^{n-1} \varphi\left(\frac{k}{n}\right) \cdot \binom{n-1}{k} \theta^k(1-\theta)^{n-1-k} \\ &= n \sum_{k=0}^{n-1} \left\{ \varphi\left(\frac{k+1}{n}\right) - \varphi\left(\frac{k}{n}\right) \right\} \cdot \binom{n-1}{k} \theta^k(1-\theta)^{n-1-k} \\ &= \sum_{k=0}^{n-1} \frac{\varphi\left(\frac{k+1}{n}\right) - \varphi\left(\frac{k}{n}\right)}{\frac{1}{n}} \cdot \binom{n-1}{k} \theta^k(1-\theta)^{n-1-k}. \end{aligned}$$

Whence by insertion,

$$B'_{n,\varphi}(\theta) - B_{n-1,\varphi'}(\theta) = \sum_{k=0}^{n-1} \left\{ \frac{\varphi\left(\frac{k+1}{n}\right) - \varphi\left(\frac{k}{n}\right)}{\frac{1}{n}} - \varphi'\left(\frac{k}{n-1}\right) \right\} \cdot \binom{n-1}{k} \theta^k(1-\theta)^{n-1-k}.$$

We have assumed from the beginning that $\varphi \in C^1([0,1])$, thus

$$\frac{\varphi\left(\frac{k+1}{n}\right) - \varphi\left(\frac{k}{n}\right)}{\frac{1}{n}} - \varphi'\left(\frac{k}{n-1}\right) = \frac{1}{n} \varepsilon\left(\frac{1}{n}\right)$$

uniformly, so the remainder term is estimated uniformly independently of k . In fact, it follows from the Mean Value Theorem that

$$\frac{\varphi\left(\frac{k+1}{n}\right) - \varphi\left(\frac{k}{n}\right)}{\frac{1}{n}} = \varphi'(\xi), \quad \text{for et passende } \xi \in \left] \frac{k}{n} \frac{k+1}{n} \left[,$$

and as $\frac{k}{n} - \frac{k}{n-1} = -\frac{k}{n(n-1)}$, we get

$$\left| \frac{k}{n} - \frac{k}{n-1} \right| \leq \frac{1}{n-1},$$

and since φ' is continuous,

$$\varphi'\left(\frac{k}{n}\right) - \varphi'\left(\frac{k}{n-1}\right) \rightarrow 0 \quad \text{ligeligt.}$$

From this follows precisely that

$$\frac{\varphi\left(\frac{k+1}{n}\right) - \varphi\left(\frac{k}{n}\right)}{\frac{1}{n}} - \varphi'\left(\frac{k}{n-1}\right) = \varphi'\left(\frac{k}{n}\right) - \varphi'\left(\frac{k}{n-1}\right) \frac{1}{n} \varepsilon \left(\frac{1}{n}\right)$$

uniformly, and the claim is proved.

Finally, we get by induction that if $\varphi \in C^k([0, 1])$, then $B_{n,\varphi}^{(k)}(\theta) \rightarrow \varphi^{(k)}(\theta)$ uniformly on $[0, 1]$.

Example 1.2 Let φ be a real continuous function defined for $x \geq 0$, and assume that $\lim_{x \rightarrow \infty} \varphi(x)$ exists (and is finite). Show that for $\varepsilon > 0$ there are $n \in \mathbb{N}$ and constants $a_k, k = 0, 1, \dots, n$, such that

$$\left| \varphi(x) - \sum_{k=0}^n a_k e^{-kx} \right| \leq \varepsilon$$

for all $x \geq 0$.

First note that the range of $e^{-x}, x \in [0, \infty[$, is $]0, 1]$, so we have $t = e^{-x} \in]0, 1]$, thus $x = \ln \frac{1}{t}$. The function $\psi(t)$, given by

$$\psi(t) = \begin{cases} \varphi\left(\ln \frac{1}{t}\right) & \text{for } t \in]0, 1], \\ \lim_{x \rightarrow \infty} \varphi(x) & \text{for } t = 0, \end{cases}$$

is continuous for $t \in [0, 1]$. It follows from Weierstraß's approximation theorem that there exists a polynomial $\sum_{k=0}^n a_k t^k$, such that

$$\left| \psi(t) - \sum_{k=0}^n a_k t^k \right| \leq \varepsilon \quad \text{for alle } t \in [0, 1].$$

Since $\varphi(x) = \psi(e^{-x})$ for $x \in [0, +\infty[$, we conclude that

$$\left| \varphi(x) - \sum_{k=0}^n a_k e^{-kx} \right| \leq \varepsilon \quad \text{for every } x \in [0, +\infty[.$$

1.2 Topological and metric spaces

Example 1.3 Let (M, d) be a metric space.

We define the open ball with centre x_0 and radius $r > 0$ by

$$B(x_0, r) = \{x \in M \mid d(x, x_0) < r\}.$$

We denote a subset $A \subset M$ open, if there for any $x_0 \in A$ is an open ball with centre x_0 contained in A .

Show that an open ball is an open set.

Show that the open sets defined in this way is a topology on M .

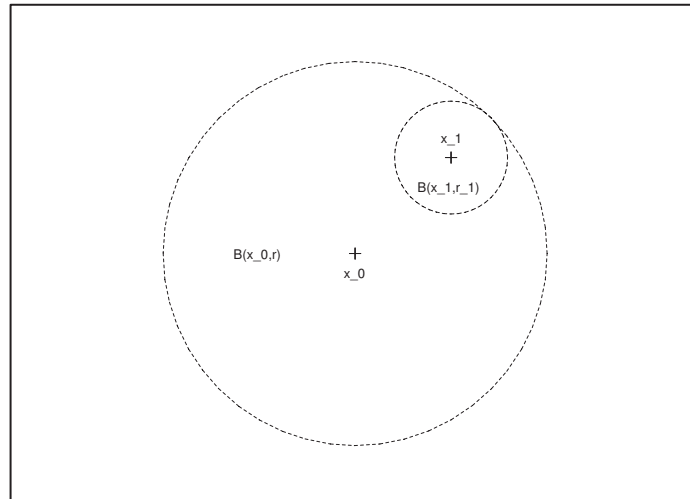

Let $x_1 \in B(x_0, r)$, i.e. $d(x_0, x_1) < r$. Choose

$$r_1 = r - d(x_0, x_1) > 0.$$

We claim that

$$B(x_1, r_1) \subseteq B(x_0, r).$$

If $x \in B(x_1, r_1)$, then

$$d(x_1, x) < r_1 = r - d(x_0, x_1),$$

and it follows by the triangle inequality that

$$d(x_0, x) \leq d(x_0, x_1) + d(x_1, x) < d(x_0, x_1) + r - d(x_0, x_1) = r,$$

proving that $x \in B(x_0, r)$. This holds for every $x \in B(x_1, r_1)$, so we have proved with the chosen radius r_1 that

$$B(x_1, r_1) \subseteq B(x_0, r),$$

hence every open ball is in fact an open set.

Then we shall prove that the system \mathcal{T} generated by all open balls is a topology. Thus a set $T \in \mathcal{T}$ is characterized by the property that for every $x \in T$ there exists an $r > 0$, such that $B(x, r) \subseteq T$.

- 1) It is trivial that M itself is an open set.
That \emptyset is open follows from the formal definition:

$$\forall x_0 \in \emptyset \exists r \in \mathbb{R}_+ : B(x_0, r) \subseteq \emptyset.$$

Since there is no point in \emptyset , the condition is trivially fulfilled.

- 2) Let $T = \bigcup_{j \in J} T_j$, where all $T_j \in \mathcal{T}$. If $x_0 \in T$, then there exists a $j \in J$, such that $x_0 \in T_j$. Since $T_j \in \mathcal{T}$, there exists an $r \in \mathbb{R}_+$, such that

$$B(x_0, r) \subseteq T_j \subseteq T,$$

thus $T \in \mathcal{T}$.

Please click the advert

www.job.oticon.dk

oticon
PEOPLE FIRST

- 3) Let $T = \bigcap_{j=1}^n T_j$, where all $T_j \in \mathcal{T}$. If $T = \emptyset$, there is nothing to prove. Therefore, let $x_0 \in T$. Then x_0 must lie in every $T_j \in \mathcal{T}$, $j = 1, \dots, n$, so there are constants $r_j \in \mathbb{R}_+$, $j = 1, \dots, n$, such that $B(x_0, r_j) \subseteq T_j$. Now put $t = \min r_j \in \mathbb{R}_+$ (notice that there is only a finite number of $r_j > 0$). Then

$$B(x_0, r) \subseteq B(x_0, r_j) \subseteq T_j \quad \text{for every } j = 1, \dots, n,$$

and hence also in the intersection,

$$B(x_0, r) \subseteq \bigcap_{j=1}^n T_j = T.$$

Using the definition of \mathcal{T} this means that $T \in \mathcal{T}$.

We have proved that \mathcal{T} is a topology.

Example 1.4 Let (M, d) be a metric space. We say that a mapping $T : M \rightarrow M$ is continuous in $x_0 \in M$ if, for any $\varepsilon > 0$ there is a $\delta > 0$ such that for all $x \in M$ we have

$$d(x_0, x) < \delta \implies d(Tx_0, Tx) < \varepsilon.$$

Show that T is continuous in x_0 if and only if

$$x_n \rightarrow x_0 \implies Tx_n \rightarrow Tx_0.$$

Show that T is continuous if the open sets are defined as in EXAMPLE 1.3.

Recall that $x_n \rightarrow x_0$ means that

$$(1) \quad \forall \delta \in \mathbb{R}_+ \exists n_0 \in \mathbb{N} \forall n \geq n_0 : d(x_n, x_0) < \delta.$$

Assume that T is continuous in $x_0 \in M$ and that $x_n \rightarrow x_0$. We shall prove that $Tx_n \rightarrow Tx_0$, i.e.

$$\forall \varepsilon \in \mathbb{R}_+ \exists n_0 \in \mathbb{N} \forall n \geq n_0 : d(Tx_n, Tx_0) < \varepsilon.$$

Let $\varepsilon \in \mathbb{R}_+$ be arbitrary. Since T is continuous, we can find to this $\varepsilon > 0$ a constant $\delta = \delta(\varepsilon) \in \mathbb{R}_+$, such that

$$(2) \quad \forall x \in M : d(x_0, x) < \delta \implies d(Tx_0, Tx) < \varepsilon.$$

Using that $x_n \rightarrow x_0$, we get by (1) an $n_0 \in \mathbb{N}$ corresponding to $\delta = \delta(\varepsilon)$ [in fact an $n_0 \in \mathbb{N}$ corresponding to $\varepsilon \in \mathbb{R}_+$], such that

$$\forall n \geq n_0 : d(x_n, x_0) < \delta = \delta(\varepsilon).$$

It follows from the continuity condition (2) that $d(Tx_0, Tx_n) < \varepsilon$ for $n \geq n_0$, hence

$$\forall \varepsilon \in \mathbb{R}_+ \exists n_0 \in \mathbb{N} \forall n \geq n_0 : d(Tx_n, Tx_0) < \varepsilon,$$

and we have proved that if T is continuous in $x_0 \in M$, then

$$x_n \rightarrow x_0 \implies Tx_n \rightarrow Tx_0.$$

Then assume that T is *not* continuous at $x_0 \in M$, thus

$$(3) \exists \varepsilon \in \mathbb{R}_+ \forall \delta \in \mathbb{R}_+ \exists x \in M : d(x_0, x) < \delta \wedge d(Tx_0, Tx) \geq \varepsilon.$$

We shall prove that there exists a sequence (x_n) , such that $x_n \rightarrow x_0$, while Tx_n does not converge towards Tx_0 .

Choose $\varepsilon > 0$ as in (3). Putting $\delta = \frac{1}{n}$ we get

$$\forall n \in \mathbb{N} \exists x_n \in M : d(x_0, x_n) < \frac{1}{n} \wedge d(Tx_0, Tx_n) \geq \varepsilon.$$

Then it follows that $x_n \rightarrow x_0$ and Tx_n cannot be arbitrarily close to Tx_0 , thus (Tx_n) does not converge towards Tx_0 .

Assume that $T^{\circ-1}(A)$ is open for every open set A . Choose $x_0 \in M$ and $A = B(Tx_0, \varepsilon)$. Then A is open, so $T^{\circ-1}(A)$ is open according to the assumption. It follows from $x_0 \in T^{\circ-1}(A)$ that there is a $\delta \in \mathbb{R}_+$, such that

$$B(x_0, \delta) \subseteq T^{\circ-1}(A).$$

For every $x_0 \in B(x_0, \delta)$, thus $d(x, x_0) < \delta$, we get $Tx \in B(Tx_0, \varepsilon)$, hence $d(Tx, Tx_0) < \varepsilon$, and we have proved that T is continuous.

Conversely, assume that T is continuous, and let A be an open set, thus

$$\forall x_0 \in A \exists r \in \mathbb{R}_+ : d(x_0, x) < r \implies x \in A.$$

We shall prove that $T^{\circ-1}(A)$ is open, i.e.

$$\forall y_0 \in T^{\circ-1}(A) \exists R \in \mathbb{R}_+ : B(y_0, R) \subseteq T^{\circ-1}(A).$$

This is done INDIRECTLY. *Assumem* that

$$\exists y_0 \in T^{\circ-1}(A) \forall R \in \mathbb{R}_+ : B(y_0, R) \setminus T^{\circ-1}(A) \neq \emptyset,$$

thus

$$\exists y_0 \in T^{\circ-1}(A) \forall R \in \mathbb{R}_+ \exists y \notin T^{\circ-1}(A) : d(y_0, y) < R.$$

Since T is continuous at y_0 , it follows that

$$\forall r \in \mathbb{R}_+ \exists R \in \mathbb{R}_+ \forall y \in M : d(y_0, y) < R \implies d(Ty_0, Ty) = d(x_0, Ty) < r.$$

We conclude that $Ty \in A$ contradicting that $y \notin T^{\circ-1}(A)$, and the claim is proved.

Example 1.5 In a set M is given a function d' from $M \times M$ to \mathbb{R} that satisfies

$$d'(x, y) = 0 \quad \text{if and only if} \quad x = y,$$

$$d'(x, y) \leq d'(z, x) + d'(z, y) \quad \text{for all } x, y, z \in M.$$

Show that (M, d') is a metric space.

If we choose $z = y$ in the latter assumption and then use the former one, we get

$$d'(x, y) \leq d'(y, x) + d'(y, y) = d'(y, x) + 0 = d'(y, x),$$

proving that

$$d'(x, y) \leq d'(y, x) \quad \text{for all } x, y \in M.$$

By interchanging x and y we obtain the opposite inequality, $d'(y, x) \leq d'(x, y)$, hence

$$d'(x, y) = d'(y, x) \quad \text{for all } x, y \in M,$$

and d' is symmetric.

Using this result on the latter assumption we get the triangle inequality

$$d'(x, y) \leq d'(x, z) + d'(z, y).$$

It only remains to prove that $d'(x, y) \geq 0$ for all $x, y \in M$ in order to conclude that d' is a metric. This follows from

$$0 = d'(x, x) \leq d'(x, y) + d'(y, x) = 2d'(x, y),$$

so the two conditions of the example suffice for d' being a metric.

Example 1.6 Let (M, d) be a metric space.

The diameter of a non-empty subset A of M is defined as

$$\delta(A) = \sup_{x, y \in A} d(x, y) \quad (\leq \infty).$$

Show that $\delta(A) = 0$ if and only if A contains only one point.

If $A = \{x\}$ only contains one point, then

$$\delta(A) = \sup_{x, y \in A} d(x, y) = d(x, x) = 0.$$

If A contains at least two points, choose $x, y \in A$, where $x \neq y$, from which we conclude that

$$\delta(A) = \sup_{t, z \in A} d(t, z) \geq d(x, y) > 0,$$

and the claim is proved.

Example 1.7 Let (M, d) be a metric space. Show that d_1 given by

$$d_1(x, y) = \frac{d(x, y)}{1 + d(x, y)} \quad \text{for } x, y \in M$$

is a metric on M .

Show that

$$\delta_1(A) = \sup_{x, y \in A} d_1(x, y) \leq 1$$

for all $A \subset M$.

Is it possible to find a subset A with $\delta_1(A) = 1$?

Show that $d_1(x_n, x) \rightarrow 0$ if and only if $d(x_n, x) \rightarrow 0$.

1) We shall first prove that

$$d_1(x, y) = \frac{d(x, y)}{1 + d(x, y)}, \quad x, y \in M,$$

is a metric.

Please click the advert



CHALLENGE YOURSELF

WWW.STUDYINSWEDEN.SE

Today's job market values ambitious, innovative, perceptive team players. Swedish universities foster these qualities through a forward-thinking culture where you're close to the latest ideas and global trends.

Whatever your career goals may be, studying in Sweden will give you valuable skills and a competitive advantage for your future. www.studyinsweden.se

Si.
Swedish Institute

- a) It is trivial that $d_1(x, y) \geq 0$, because $d(x, y) \geq 0$.
 b) Then we see that $d_1(x, y) = 0$, if and only if the numerator $d(x, y) = 0$, i.e. if and only if $x = y$.
 c) The condition $d_1(x, y) = d_1(y, x)$ follows immediately from $d(x, y) = d(y, x)$.
 d) It remains only to prove the triangle inequality

$$d_1(x, y) \leq d_1(x, z) + d_1(z, y).$$

Now $d(x, y) \leq d(x, z) + d(z, y)$, and the function

$$f(t) = \frac{t}{1+t} = 1 - \frac{1}{1+t}, \quad t \geq 0,$$

is increasing. Hence

$$\begin{aligned} d_1(x, y) &= \frac{d(x, y)}{1+d(x, y)} = f(d(x, y)) \\ &\leq f(d(x, z) + d(z, y)) = \frac{d(x, z) + d(z, y)}{1+d(x, z) + d(z, y)} \\ &= \frac{d(x, z)}{1+d(x, z) + d(z, y)} + \frac{d(z, y)}{1+d(x, z) + d(z, y)} \\ &\leq \frac{d(x, z)}{1+d(x, z)} + \frac{d(z, y)}{1+d(z, y)} \\ &= d_1(x, z) + d_1(z, y). \end{aligned}$$

Summing up, we have proved that $d_1(x, y)$ is a metric on M .

- 2) It follows from

$$d_1(x, y) = \frac{d(x, y)}{1+d(x, y)} = 1 - \frac{1}{1+d(x, y)} \leq 1,$$

that

$$\delta_1(A) = \sup_{x, y \in A} d_1(x, y) \leq 1$$

for every subset A .

- 3) a) If the metric d is not bounded on M , then there are subsets A , such that $\delta_1(A) = 1$.
 In fact, we choose to every $n \in \mathbb{N}$ points $x_n, y_n \in M$, such that

$$d(x_n, y_n) \geq n - 1 \quad \text{for } n \in \mathbb{N}.$$

As mentioned previously, $f(t) = \frac{t}{1+t}$ is increasing, so

$$d_1(x_n, y_n) = f(d(x, y)) \geq f(n - 1) = \frac{n - 1}{n} = 1 - \frac{1}{n}.$$

Putting

$$A = \{x_n \mid n \in \mathbb{N}\} \cup \{y_n \mid n \in \mathbb{N}\},$$

it follows that $\delta_1(A) \geq 1 - \frac{1}{n}$ for every $n \in \mathbb{N}$, thus $\delta_1(A) \geq 1$. On the other hand, we have already proved that $\delta_1(A) \leq 1$, so we conclude that $\delta_1(A) = 1$.

b) If instead d is bounded on M , then M has itself a finite d -diameter, $\delta(M) = c < \infty$, and

$$\delta_1(M) = \frac{c}{1+c} = 1 - \frac{1}{1+c} < 1.$$

There are many examples of such metrics. The most obvious one is the well-known

$$d_0(x, y) = \begin{cases} 0 & \text{for } x = y, \\ 1 & \text{for } x \neq y, \end{cases}$$

where

$$\tilde{d}_0(x, y) = \begin{cases} 0 & \text{for } x = y, \\ \frac{1}{2} & \text{for } x \neq y. \end{cases}$$

We get another example by starting with the bounded d_1 above. Then

$$d_2(x, y) = \frac{d_1(x, y)}{1 + d_1(x, y)} = \frac{d(x, y)}{1 + 2d(x, y)},$$

with $\delta_2(A) \leq \frac{1}{2}$ for every subset $A \subseteq M$.

4) It follows from

$$d_1(x_n, x) = 1 - \frac{1}{1 + d(x_n, x)},$$

that the condition $d_1(x_n, x) \rightarrow 0$ is equivalent with $1 + d(x_n, x) \rightarrow 1$, thus with $d(x_n, x) \rightarrow 0$, and the claim is proved.

Example 1.8 Let (M_1, d_1) and (M_2, d_2) be metric spaces.

Show that $M_1 \times M_2$ can be made into a metric space by the following definition of a metric d :

$$d((x_1, x_2), (y_1, y_2)) = d_1(x_1, y_1) + d_2(x_2, y_2).$$

Show that also d^* given by

$$d^*((x_1, x_2), (y_1, y_2)) = \max\{d_1(x_1, y_1), d_2(x_2, y_2)\}$$

defines a metric on $M_1 \times M_2$.

1) Clearly,

$$d((x_1, x_2), (y_1, y_2)) \geq 0 \quad \text{and} \quad d^*((x_1, x_2), (y_1, y_2)) \geq 0.$$

2) If $(x_1, x_2) = (y_1, y_2)$, i.e. $x_1 = y_1$ and $x_2 = y_2$, then

$$d((x_1, x_2), (y_1, y_2)) = 0 \quad \text{and} \quad d^*((x_1, x_2), (y_1, y_2)) = 0.$$

Conversely, if

$$d((x_1, x_2), (y_1, y_2)) = 0 \quad \text{or} \quad d^*((x_1, x_2), (y_1, y_2)) = 0,$$

then both

$$d_1(x_1, y_1) = 0 \quad \text{and} \quad d_2(x_2, y_2) = 0,$$

and it follows that $x_1 = y_1$ and $x_2 = y_2$, and hence $(x_1, x_2) = (y_1, y_2)$.

- 3) The symmetry is obvious.
- 4) The triangle inequality holds for both d_1 and d_2 . Hence, it also holds for d and d^* . In fact,

$$\begin{aligned} d((x_1, x_2), (y_1, y_2)) &= d_1(x_1, y_1) + d_2(x_2, y_2) \\ &\leq \{d_1(x_1, z_1) + d_1(z_1, y_1)\} + \{d_2(x_2, z_2) + d_2(z_2, y_2)\} \\ &= \{d_1(x_1, z_1) + d_2(x_2, z_2)\} + \{d_1(z_1, y_1) + d_2(z_2, y_2)\} \\ &= d((x_1, x_2), (z_1, z_2)) + d((z_1, z_2), (y_1, y_2)), \end{aligned}$$

and

$$\begin{aligned} d^*((x_1, x_2), (y_1, y_2)) &= \max\{d_1(x_1, y_1), d_2(x_2, y_2)\} \\ &\leq \max\{d_1(x_1, z_1) + d_1(z_1, y_1), d_2(x_2, z_2) + d_2(z_2, y_2)\} \\ &\leq \max\{d_1(x_1, z_1), d_2(x_2, z_2)\} + \max\{d_1(z_1, y_1), d_2(z_2, y_2)\} \\ &= d^*((x_1, x_2), (z_1, z_2)) + d^*((z_1, z_2), (y_1, y_2)). \end{aligned}$$

Example 1.9 Show that in any set M we can define a metric by

$$d(x, y) = \begin{cases} 0 & \text{if } x = y, \\ 1 & \text{if } x \neq y. \end{cases}$$

Then we call (M, d) for a discrete metric space.

Characterize the sequences in M where $d(x_n, x) \rightarrow 0$.

- 1) Clearly, $d(x, y) \geq 0$.
- 2) Clearly, $d(x, y) = 0$, if and only if $x = y$.
- 3) Clearly, $d(x, y) = d(y, x)$.
- 4) Finally, it is almost trivial that

$$d(x, y) \leq d(x, z) + d(z, y),$$

because the left hand side is always ≤ 1 . If the right hand side is < 1 , then both $d(x, z) = 0$ and $d(z, y) = 0$, and we infer that $x = z$ and $z = y$, hence also $x = y$. This implies that the left hand side $d(x, y) = 0$, and the triangle inequality is fulfilled.

Summing up we have proved that (M, d) is a metric space.

If $d(x_n, x) \rightarrow 0$, then choose $\varepsilon = \frac{1}{2}$. There exists an $n_0 \in \mathbb{N}$, such that

$$d(x_n, x) < \varepsilon = \frac{1}{2} \quad \text{for } n \geq n_0.$$

This is only possible, if $d(x_n, x) = 0$, i.e. if

$$x_n = x \quad \text{for all } n \geq n_0.$$

We conclude that all the convergent sequences are constant eventually.

Please click the advert

Turning a challenge into a learning curve. Just another day at the office for a high performer.

Accenture Boot Camp – your toughest test yet

Choose Accenture for a career where the variety of opportunities and challenges allows you to make a difference every day. A place where you can develop your potential and grow professionally, working alongside talented colleagues. The only place where you can learn from our unrivalled experience, while helping our global clients achieve high performance. If this is your idea of a typical working day, then Accenture is the place to be.

It all starts at Boot Camp. It's 48 hours that will stimulate your mind and enhance your career prospects. You'll spend time with other students, top Accenture Consultants and special guests. An inspirational two days

packed with intellectual challenges and activities designed to let you discover what it really means to be a high performer in business. We can't tell you everything about Boot Camp, but expect a fast-paced, exhilarating

and intense learning experience. It could be your toughest test yet, which is exactly what will make it your biggest opportunity.

Find out more and apply online.

Visit [accenture.com/bootcamp](https://www.accenture.com/bootcamp)

• Consulting • Technology • Outsourcing

High performance. Delivered.

Example 1.10 Let (M, d) be a metric space and consider M as a topological space with the topology stemming from the open balls (the ball topology).

Recall that a set A is closed if $M \setminus A$ is open.

Show that $A \subset M$ is closed if and only if

$$x_n \in A, \quad x_n \rightarrow x \quad \implies \quad x \in A.$$

Show that if (M, d) is a complete metric space and A is a closed subset of M , then (A, d) is a complete metric space.

Assume that A is closed and let $x_n \in A$ be a convergent sequence in M , i.e. $x_n \rightarrow x \in M$. We shall prove that $x \in A$.

INDIRECT PROOF. Assume that $x \notin A$, i.e. $x \in M \setminus A$, which is open.

There exists an $r > 0$, such that

$$B(x, r) \subseteq M \setminus A, \quad \text{i.e.} \quad B(x, r) \cap A = \emptyset.$$

Now, $x_n \rightarrow x$, so there exists an $n_r \in \mathbb{N}$, such that

$$d(x_n, x) < r \quad \text{for } n \geq n_r,$$

and we see that $x_n \in B(x, r) \cap A = \emptyset$, which is not possible. Hence our assumption is wrong, so we conclude that $x \in A$.

Conversely, assume for every convergent sequence $(x_n) \subseteq A$ the limit point lies in A . We shall prove that A is closed, or equivalently that $M \setminus A$ is open.

INDIRECT PROOF. Assume that $M \setminus A$ is *not* open. There exists an $x \in M \setminus A$, such that

$$\forall r \in \mathbb{R}_+ \exists y \in A : d(x, y) < r.$$

If we put $r = \frac{1}{n}$, $n \in \mathbb{N}$, with corresponding $y = x_n$, we define a sequence in A , which converges towards x , thus $x \in A$ according to the assumption. This is contradicting the assumption that $x \in M \setminus A$. Hence this assumption must be wrong, and $x \in A$ as requested.

Finally, assume that (M, d) is a *complete* metric space and that A is a *closed* subset of M . We shall prove that (A, d) is complete.

Let (x_n) be a Cauchy sequence on A . Then (x_n) is also a Cauchy sequence on the complete metric space M , thus (x_n) converges in M towards the limit $x \in M$. However, A is a closed subset, so it follows from the previous result that $x \in A$. We have proved that every Cauchy sequence (x_n) on A has a limit $x \in A$, which means that (A, d) is complete.

Example 1.11 Show that

$$d(x, y) = |\arctan x - \arctan y|$$

defines a metric on \mathbb{R} .

The definition includes an absolute value, hence $d(x, y) \geq 0$ for all $x, y \in \mathbb{R}$.

The function $\arctan t$ is strictly increasing on \mathbb{R} , hence $d(x, y) = 0$, if and only if $x = y$.

Clearly, $d(x, y) = d(y, x)$.

The triangle inequality follows from

$$d(x, y) = |\arctan x - \arctan y| \leq |\arctan x - \arctan z| + |\arctan z - \arctan y| = d(x, z) + d(z, y).$$

Example 1.12 In \mathbb{R}^k we define

$$d_1(x, y) = \sum_{i=1}^k |x_i - y_i|,$$

$$d_2(x, y) = \left(\sum_{i=1}^k |x_i - y_i|^2 \right)^{\frac{1}{2}},$$

$$d_\infty(x, y) = \max_{1 \leq i \leq k} |x_i - y_i|.$$

Show that d_1 , d_2 and d_∞ are metrics.

Show that

$$d_\infty(x, y) \leq d_1(x, y) \leq k d_\infty(x, y),$$

and find a similar inequality when d_1 is replaced by d_2 .

Show that if a sequence (x_n) converges to x in one of these metrics, then we have coordinate wise convergence:

$$x_{ni} \rightarrow x_i \quad \text{for all } i = 1, 2, \dots, k.$$

We first prove that

$$d_1(x, y) = \sum_{i=1}^k |x_i - y_i|$$

is a metric:

- 1) Clearly, $d_1(x, y) \geq 0$.
- 2) Clearly, $d_1(x, y) = 0$, if and only if $x = y$.
- 3) Clearly, $d_1(x, y) = d_1(y, x)$.

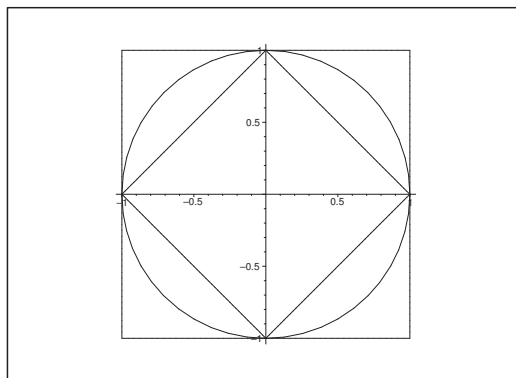

Figure 1: The three unit balls for d_1 (innermost), d_2 (the disc) and d_∞ (largest) in the case \mathbb{R}^2 .

4) The triangle inequality follows by a small computation

$$\begin{aligned} d_1(x, y) &= \sum_{i=1}^k |x_i - y_i| \leq \sum_{i=1}^k \{|x_i - z_i| + |z_i - y_i|\} \\ &= \sum_{i=1}^k |x_i - z_i| + \sum_{i=1}^k |z_i - y_i| = d_1(x, z) + d_1(z, y). \end{aligned}$$

We have proved that d_1 is a metric.

Then we prove that

$$d_2(x, y) = \left(\sum_{i=1}^k |x_i - y_i|^2 \right)^{\frac{1}{2}}$$

is a metric. Again, the first three conditions are trivial. The triangle inequality,

$$\sqrt{\sum_{i=1}^k |x_i - y_i|^2} \leq \sqrt{\sum_{i=1}^k |x_i - z_i|^2} + \sqrt{\sum_{i=1}^k |z_i - y_i|^2}$$

is, however, more difficult to prove. There are several proofs of the triangle inequality of d_2 . Here we shall not choose the most elegant one, but instead the intuitively most obvious one.

Put $a_i = x_i - z_i$ and $b_i = z_i - y_i$, $i = 1, \dots, k$. We shall prove that

$$\sqrt{\sum_{i=1}^k (a_i + b_i)^2} \leq \sqrt{\sum_{i=1}^k a_i^2} + \sqrt{\sum_{i=1}^k b_i^2}.$$

All terms are ≥ 0 , thus it is seen by squaring that we shall prove that

$$\sum_{i=1}^k a_i^2 + \sum_{i=1}^k b_i^2 + 2 \sum_{i=1}^k a_i b_i \leq \sum_{i=1}^k a_i^2 + \sum_{i=1}^k b_i^2 + 2 \sqrt{\sum_{i=1}^k \sum_{j=1}^k a_i^2 b_j^2},$$

which is reduced to the equivalent condition

$$\sum_{i=1}^k a_i b_i \leq \sqrt{\sum_{i=1}^k a_i^2} \cdot \sqrt{\sum_{j=1}^k b_j^2}.$$

The claim follows if we can prove the CAUCHY-SCHWARZ INEQUALITY

$$\left| \sum_{i=1}^k a_i b_i \right| \leq \sqrt{\sum_{i=1}^k a_i^2} \cdot \sqrt{\sum_{j=1}^k b_j^2}.$$

Another squaring shows that it suffices to prove that

$$\left(\sum_{i=1}^k a_i b_i \right)^2 \leq \sum_{i=1}^k a_i^2 \sum_{j=1}^k b_j^2,$$

i.e.

$$\sum_{i=1}^k a_i^2 b_i^2 + 2 \sum_{i=1}^{k-1} \sum_{j=i+1}^k a_i a_j b_i b_j \leq \sum_{i=1}^k a_i^2 b_i^2 + \sum_{i=1}^{k-1} \sum_{j=i+1}^k (a_i^2 b_j^2 + a_j^2 b_i^2),$$

which again is equivalent with

$$0 \leq \sum_{i=1}^{k-1} \sum_{j=i+1}^k (a_i^2 b_j^2 + a_j^2 b_i^2 - 2a_i a_j b_i b_j) = \sum_{i=1}^{k-1} \sum_{j=i+1}^k (a_i b_j - a_j b_i)^2.$$

The latter is clearly satisfied. Since we everywhere have computed “ \Leftarrow ”, the claim is proved.

Please click the advert



it's an **interesting** world

Get under the skin of it.

Graduate opportunities
Cheltenham | £24,945 + benefits

One of the UK's intelligence services, GCHQ's role is two-fold: to gather and analyse intelligence which helps shape Britain's response to global events, and, to provide technical advice for the protection of Government communication and information systems. In doing so, our specialists – in IT, internet, engineering, languages, information assurance, mathematics and intelligence – get well beneath the surface of global affairs. If you thought the world was an interesting place, you really ought to explore our world of work.

www.careersinbritishintelligence.co.uk

Applicants must be British citizens. GCHQ values diversity and welcomes applicants from all sections of the community. We want our workforce to reflect the diversity of our work.



Finally,

$$d_\infty(x, y) = \max_{1 \leq i \leq k} |x_i - y_i|$$

is a metric, because the first three conditions again are trivial, and the triangle inequality follows from

$$|x_i - y_i| \leq |x_i - z_i| + |z_i - y_i| \quad \text{for every } i = 1, \dots, k,$$

thus

$$|x_i - y_i| \leq d_\infty(x, z) + d_\infty(z, y) \quad \text{for every } i = 1, \dots, k,$$

and by taking the maximum once more,

$$d_\infty(x, y) \leq d_\infty(x, z) + d_\infty(z, y).$$

We have now proved that d_1 , d_2 and d_∞ are all metrics.

We can find $j \in \{1, \dots, k\}$, such that

$$\begin{aligned} d_\infty(x, y) &= \max_{1 \leq i \leq k} |x_i - y_i| = |x_j - y_j| \leq \sum_{i=1}^k |x_i - y_i| = d_1(x, y) \\ &\leq \sum_{i=1}^k \max |x_i - y_i| = k \cdot d_\infty(x, y). \end{aligned}$$

Analogously (with the same “maximal” j),

$$\begin{aligned} d_\infty(x, y) &= \max_{1 \leq i \leq k} |x_i - y_i| = |x_j - y_j| = \sqrt{|x_j - y_j|^2} \\ &\leq \sqrt{\sum_{i=1}^k |x_i - y_i|^2} = d_2(x, y) \leq \sqrt{\sum_{i=1}^k \left\{ \max_{1 \leq i \leq k} |x_i - y_i| \right\}^2} \\ &= \sqrt{\sum_{i=1}^k \{d_\infty(x, y)\}^2} = \sqrt{k} \cdot d_\infty(x, y), \end{aligned}$$

and the wanted inequality becomes

$$d_\infty(x, y) \leq d_2(x, y) \leq \sqrt{k} \cdot d_\infty(x, y).$$

Remark 1.1 A simple squaring shows that $d_2(x, y) \leq d_1(x, y)$, which can also be seen on the figure (the simple proof is left to the reader). This means that

$$d_\infty(x, y) \leq d_2(x, y) \leq d_1(x, y) \leq k \cdot d_\infty(x, y). \quad \diamond$$

Using that $x_{ni} \rightarrow x_i$ for every $i = 1, 2, \dots, k$, if and only if $d_\infty(x_n, x) \rightarrow 0$, we conclude from the inequalities

$$d_\infty(x, y) \leq d_1(x, y) \leq k \cdot d_\infty(x, y),$$

$$d_\infty(x, y) \leq d_2(x, y) \leq \sqrt{k} \cdot d_\infty(x, y),$$

that this is fulfilled if and only if $d_1(x_n, 0) \rightarrow 0$, and if and only if $d_2(x, y) \rightarrow 0$.

Example 1.13 Let c denote the set of convergent complex sequences $x = (x_1, x_2, \dots)$. Show that c is a complete metric space when equipped with the metric

$$d_\infty(x, y) = \sup_i |x_i - y_i|.$$

HINT: Show that the space of bounded complex sequences ℓ^∞ is a complete space and show then that c is a closed subset, then apply Example 1.10.

Let $x^n = (x_1^n, x_2^n, \dots)$, where $\lim_{i \rightarrow \infty} x_i^n$ exists, be a Cauchy sequence from c , thus

$$\forall \varepsilon > 0 \exists N \in \mathbb{N} \forall m, n \geq N : d(x^m, x^n) < \varepsilon.$$

This means that

$$\sup_i |x_i^m - x_i^n| < \varepsilon.$$

In particular, $(x_i^n)_n$ is a Cauchy sequence on \mathbb{R} for every i , hence convergent,

$$\lim_{n \rightarrow \infty} x_i^n = x_i.$$

The *Hint* is *not* used, because it is not hard to prove directly that $(x_i) \in c$. It suffices to prove that (x_i) is a Cauchy sequence, i.e.

$$(4) \quad \forall \varepsilon > 0 \exists I \in \mathbb{N} \forall i, j \geq I : |x_i - x_j| < \varepsilon.$$

It follows from

$$|x_i - x_j| \leq |x_i - x_i^n| + |x_i^n - x_j^n| + |x_j^n - x_j|,$$

and $(x_i^n)_n \rightarrow x_i$, and even

$$\sup_i |x_i - x_i^n| \rightarrow 0 \quad \text{for } n \rightarrow \infty,$$

that

$$a) \quad \forall \varepsilon > 0 \exists N \forall n \geq N \forall i : |x_i - x_i^n| < \frac{\varepsilon}{3},$$

$$b) \quad \forall \varepsilon > 0 \forall n \exists I(n) \forall i, j \geq I(n) : |x_i^n - x_j^n| < \frac{\varepsilon}{3}.$$

First choose N , such that a) is fulfilled.

Then choose $I = I(N)$, such that b) is fulfilled for $n = N$.

If $i, j \geq I = I(N)$, then

$$\begin{aligned} |x_i - x_j| &\leq |x_i - x_i^N| + |x_i^N - x_j^N| + |x_j^N - x_j| \\ &< \frac{\varepsilon}{3} + \frac{\varepsilon}{3} + \frac{\varepsilon}{3} = \varepsilon, \end{aligned}$$

which is (4), and we have proved that (x_i) is a Cauchy sequence on \mathbb{R} , hence convergent. In particular, (x_i) is bounded, so $(x_i) \in c$, and c is complete.

Example 1.14 In the set of bounded complex sequences ℓ^∞ equipped with the metric from EXERCISE 12 we consider the sets c_0 consisting of the sequences converging to 0 and c_{00} consisting of the sequences with only a finite number of elements different from 0. Investigate if c_0 and/or c_{00} are closed subsets of ℓ^∞ .

The sequence $\left(\frac{1}{n}\right)$ belongs to ℓ^∞ , though it does not belong to c_{00} . Choose

$$x^n = \left(1, \frac{1}{2}, \dots, \frac{1}{n}, 0, 0, \dots\right).$$

Then $x^n \in c_{00}$ and $x^n \rightarrow x = \left(\frac{1}{n}\right) \notin c_{00}$, hence c_{00} is not closed.

Let $x^n = (x_1^n, x_2^n, \dots) \in c_0$ be convergent in ℓ^∞ , i.e. $\lim_{i \rightarrow \infty} x_i^n = 0$ for every n . There exists an $x \in \ell^\infty$, such that

$$\forall \varepsilon > 0 \exists n_0 \forall n \geq n_0 : \|x - x^n\|_\infty = \sup_i |x_i - x_i^n| < \varepsilon.$$

We shall prove that $\lim_{i \rightarrow \infty} x_i = 0$. Now,

$$|x_i| \leq |x_i - x_i^n| + |x_i^n| \leq \|x - x^n\|_\infty + |x_i^n|.$$

First choose n , such that $\|x - x^n\|_\infty < \frac{\varepsilon}{2}$.

Then choose I , such that $|x_i^n| < \frac{\varepsilon}{2}$ for every $i \geq I$. Summing up we get for all $i \geq I$ that

$$|x_i| < \frac{\varepsilon}{2} + \frac{\varepsilon}{2} = \varepsilon.$$

Please click the advert

Brain power

By 2020, wind could provide one-tenth of our planet's electricity needs. Already today, SKF's innovative know-how is crucial to running a large proportion of the world's wind turbines.

Up to 25 % of the generating costs relate to maintenance. These can be reduced dramatically thanks to our systems for on-line condition monitoring and automatic lubrication. We help make it more economical to create cleaner, cheaper energy out of thin air.

By sharing our experience, expertise, and creativity, industries can boost performance beyond expectations. Therefore we need the best employees who can meet this challenge!

The Power of Knowledge Engineering

Plug into The Power of Knowledge Engineering.
Visit us at www.skf.com/knowledge

SKF

1.3 Contractions

Example 1.15 Consider the metric space (M, d) , where $M = [1, \infty[$, and d the usual distance. Let the mapping $T : M \rightarrow M$ be given by

$$Tx = \frac{x}{2} + \frac{1}{x}.$$

Show that T is a contraction and find the minimal contraction constant α . Find also the fixed point.

First compute

$$|Tx - Ty| = \left| \frac{x}{2} + \frac{1}{x} - \frac{y}{2} - \frac{1}{y} \right| = \left| \frac{x-y}{2} + \frac{1}{x} - \frac{1}{y} \right| = \left| \frac{x-y}{2} + \frac{y-x}{xy} \right| = |x-y| \cdot \left| \frac{1}{2} - \frac{1}{xy} \right|.$$

Now, $x, y \geq 1$, so $0 < \frac{1}{xy} \leq 1$, and the function

$$(x, y) \mapsto \frac{1}{2} - \frac{1}{xy}$$

has the range $\left[-\frac{1}{2}, \frac{1}{2}\right]$. We conclude that $\alpha = \frac{1}{2}$, so $\frac{1}{2}$ is the smallest α , for which

$$\left| \frac{1}{2} - \frac{1}{xy} \right| \leq \alpha.$$

The fixpoint satisfies the equation $Tx = x$, thus

$$x = \frac{x}{2} + \frac{1}{x}, \quad \text{hence } \frac{x}{2} = \frac{1}{x}, \quad \text{i.e. } x^2 = 2.$$

Since $x \geq 1$, the fixpoint must be $x = \sqrt{2}$, which also is easily seen by insertion.

Since $\alpha = \frac{1}{2} < 1$, it follows from the above that it is the only fixpoint.

Example 1.16 A mapping T from a metric space (M, d) into itself is called a weak contraction if

$$d(Tx, Ty) < d(x, y),$$

for all $x, y \in M$, $x \neq y$.

Show that T has at most one fixed point.

Show that T does not necessarily have a fixed point.

HINT: One should take $Tx = x + \frac{1}{x}$ for $x \geq 1$.

Let T be a weak contraction, and assume that both x and y are fixpoints, i.e. $Tx = x$ and $Ty = y$.

If $x \neq y$, then

$$d(x, y) = d(Tx, Ty) < d(x, y),$$

which is not possible. Hence $y = x$, and there is at most one fixpoint.

Define $Tx = x + \frac{1}{x}$ on $[1, +\infty[$. If $x, y \in [1, +\infty[$, then

$$|Tx - Ty| = \left| x + \frac{1}{x} - y - \frac{1}{y} \right| = \left| x - y + \frac{y - x}{xy} \right| = |x - y| \cdot \left| 1 - \frac{1}{xy} \right|.$$

It follows from $0 < \frac{1}{xy} \leq 1$ for $x, y \geq 1$, that

$$|Tx - Ty| < |x - y| \quad \text{for } x \neq y,$$

and T is a weak contraction on $[1, +\infty[$.

The weak contraction $Tx = x + \frac{1}{x}$ does not have a fixpoint, because $Tx = x$ would imply that $\frac{1}{x} = 0$, which is not possible.

Example 1.17 *It is very common in mathematical analysis to consider iterations of the form*

$$x_n = g(x_{n-1}),$$

where g is a C^1 -function. Show that the sequence (x_n) is convergent for any choice of x_0 if there is an α , $0 < \alpha < 1$, such that

$$|g'(x)| \leq \alpha$$

for all $x \in \mathbb{R}$.

It follows from the Mean Value Theorem that one to any x and y can find $t = t(x, y)$ between x and y , such that

$$g(x) - g(y) = g'(t) \cdot (x - y),$$

thus

$$|g(x) - g(y)| = |g'(t)| \cdot |x - y| \leq \alpha |x - y|.$$

This proves that g is a contraction, and the claim follows from Banach's Fixpoint Theorem.

Example 1.18 *To approximate the solution to an equation $f(x) = 0$, we bring the equation on the form $x = g(x)$ and choose an x_0 and use the iteration $x_n = g(x_{n-1})$. Assume that g is a C^1 -function on the interval $[x_0 - \delta; x_0 + \delta]$, and that $|g'(x)| \leq \alpha < 1$ for $x \in [x_0 - \delta; x_0 + \delta]$, and moreover*

$$|g(x_0) - x_0| \leq (1 - \alpha)\delta.$$

Show that there is one and only one solution $x \in [x_0 - \delta; x_0 + \delta]$ to the equation, and that $x_n \rightarrow x$.

Noticing that $|g'(x)| \leq \alpha < 1$ on the interval $[x_0 - \delta; x_0 + \delta]$, the claim follows from Banach's Fixpoint Theorem, if we only can prove that the iterative sequence (x_n) lies entirely in the interval $[x_0 - \delta, x_0 + \delta]$. We prove this by induction.

It is obvious that $x_0 \in [x_0 - \delta, x_0, \delta]$.

Assume that $x_n \in [x_0 - \delta, x_0 + \delta]$. Then we get for the following element $x_{n+1} = g(x_n)$,

$$\begin{aligned} |x_{n+1} - x_0| &= |g(x_n) - x_0| \\ &\leq |g(x_n) - g(x_0)| + |g(x_0) - x_0| \\ &\leq \alpha |x_n - x_0| + (1 - \alpha)\delta \\ &\leq \alpha \delta + (1 - \alpha)\delta = \delta, \end{aligned}$$

proving that $x_{n+1} \in [x_0 - \delta, x_0 + \delta]$, and the claim follows.

Example 1.19 Solve by iteration the equation $f(x) = 0$ for $f \in C^1([a, b])$, $f(x) < 0 < f(b)$ and f' bounded and strictly positive in $[a, b]$.

HINT: Take $g(x) = x - \lambda f(x)$ for a smart choice of λ .

Putting

$$g(x) = x - \lambda f(x), \quad \lambda \neq 0,$$

it follows that $f(x) = 0$, if and only if $g(x) = x$. Now,

$$g'(x) = 1 - \lambda f'(x) \quad \text{and} \quad 0 < k_1 \leq f'(x) \leq k_2,$$

so

$$1 - \lambda k_2 \leq g'(x) \leq 1 - \lambda k_1.$$

If we choose $\lambda = \frac{1}{k_2}$, then

$$0 \leq g'(x) \leq 1 - \frac{k_1}{k_2} = \alpha < 1,$$

and the mapping $g : [a, b] \rightarrow [a, b]$ is increasing and a contraction, so it has by Banach's Fixpoint Theorem precisely one fixpoint in $[a, b]$.

Example 1.20 Show that it is possible to solve the equation $f(x)x^3 + x - 1 = 0$ by the iteration

$$x_n = g(x_{n-1}) = (1 + x_{n-1}^2)^{-1}.$$

Find x_1, x_2, x_3 for $x_0 = 1$, and find an estimate for $d(x, x_n)$.

Let $g(x) = \frac{1}{1 + x^2}$. Then $g(x) = x$ is equivalent with $x = \frac{1}{1 + x^2}$, thus $x(1 + x^2) = 1$, which we write as

$$f(x) = x^3 + x - 1 = 0,$$

i.e. exactly the equation we want to solve.

It follows from

$$g'(x) = -\frac{2x}{(1 + x^2)^2},$$

and

$$g''(x) = -\frac{2}{(1+x^2)^2} - 2x \cdot \frac{(-2) \cdot 2x}{(1+x^2)^3} = \frac{2}{(1+x^2)^3} \{-1 - x^2 + 4x^2\} = \frac{6\left(x^2 - \frac{1}{3}\right)}{(1+x^2)^3},$$

that $g''(x) = 0$ for $x = \pm \frac{1}{\sqrt{3}}$. Since $g'(x) \rightarrow 0$ for $x \rightarrow \pm\infty$, these points correspond to maximum and minimum for $g'(x)$, thus

$$|g'(x)| \leq \frac{2 \cdot \frac{1}{\sqrt{3}}}{\left(1 + \frac{1}{3}\right)^2} = \frac{\frac{2}{\sqrt{3}}}{\frac{16}{9}} = \frac{3\sqrt{3}}{8} = \alpha \leq 0.65,$$

and we have proved that g is a contraction, so the equation

$$f(x) = x^3 + x - 1 = 0$$

can be solved by the given iteration.

Let $x_0 = 1$. Then

$$x_1 = g(x_0) = \frac{1}{1+1} = \frac{1}{2},$$

$$x_2 = g\left(\frac{1}{2}\right) = \frac{1}{1 + \frac{1}{4}} = \frac{4}{5},$$

$$x_3 = g\left(\frac{4}{5}\right) = \frac{1}{1 + \frac{16}{25}} = \frac{25}{41}.$$

Finally,

$$|x - x_n| \leq \frac{\alpha^n}{1 - \alpha} \cdot |x_1 - x_0|,$$

so

$$|x - x_n| \leq \frac{\left(\frac{3\sqrt{3}}{8}\right)^n}{1 - \frac{3\sqrt{3}}{8}} \cdot \left(1 - \frac{1}{2}\right) = \frac{4}{8 - 3\sqrt{3}} \cdot \left(\frac{3\sqrt{3}}{8}\right)^n = \frac{4}{8 - 3\sqrt{3}} \cdot \left(\frac{27}{64}\right)^{\frac{n}{2}} < \frac{3}{2} \cdot \left(\frac{27}{64}\right)^{\frac{n}{2}}.$$

When we apply the iteration above on a pocket calculator, we get

$$x = 0.682\,327\,804.$$

Remark 1.2 The iteration above can therefore be applied, though it is far from the fastest one. If the preset case we get by *Newton's iteration formula*

$$x_{n+1} = x_n - \frac{f(x_n)}{f'(x_n)} = \frac{2}{3}x_n + \frac{1}{3} \cdot \frac{3 - 2x_n}{3x_n^2 + 1},$$

from which already

$$x_4 = 0.682\,327\,804. \quad \diamond$$

Example 1.21 A mapping $T : \mathbb{R} \rightarrow \mathbb{R}$ satisfies a Lipschitz condition with constant k , if

$$|Tx - Ty| \leq k|x - y|, \quad \text{for all } x, y \in \mathbb{R}.$$

- 1) Is T a contraction?
- 2) If T is a C^1 -function with bounded derivative, show that T satisfies a Lipschitz condition.
- 3) If T satisfies a Lipschitz condition, is T then a C^1 -function with bounded derivative?
- 4) Assume that $|Tx - Ty| \leq k|x - y|^\alpha$ for some $\alpha > 1$. Show that T is a constant.

- 1) If $k \geq 1$, then T is not necessarily a contraction.
If instead $0 \leq k < 1$, then T is always a contraction.

- 2) It follows from the Mean Value Theorem that

$$|T(x) - T(y)| = |T'(t)| \cdot |x - y|,$$

where $t = t(x, y)$ lies somewhere between x and y .

Since $|T'(t)| \leq k$, it is obvious that T fulfils a Lipschitz condition.

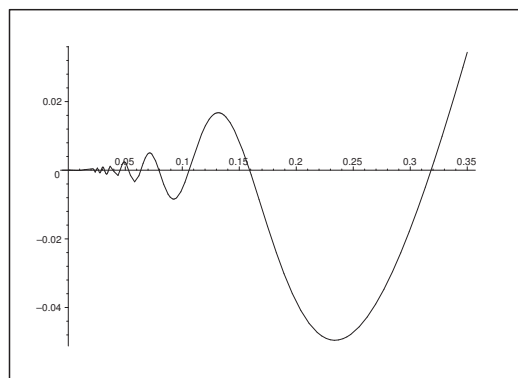

Figure 2: The graph of $f(x) = x^2 \cdot \sin \frac{1}{x}$ for $0 < x < 0.35$.

3) The answer is “no”. Choose the function

$$f(x) = \begin{cases} x^2 \cdot \sin \frac{1}{x} & \text{for } x > 0, \\ 0 & \text{for } x \leq 0. \end{cases}$$

Then f is differentiable with the derivative

$$f'(x) = \begin{cases} 2x \cdot \sin \frac{1}{x} - \cos \frac{1}{x} & \text{for } x > 0, \\ \lim_{x \rightarrow 0^+} \frac{f(x) - f(0)}{x - 0} = \lim_{x \rightarrow 0^+} x \cdot \sin \frac{1}{x} = 0 & \text{for } x = 0, \\ 0 & \text{for } x < 0. \end{cases}$$

Choose $x_0 > 0$, such that $f'(x_0) = 0$, and put

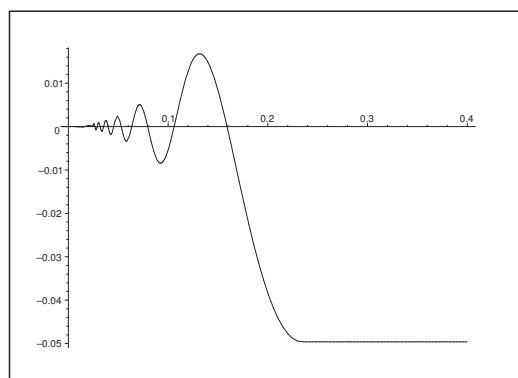

Figure 3: An example of a function $T(x)$.

$$T(x) = \begin{cases} f(x_0) & \text{for } x \geq x_0, \\ x^2 \cdot \sin \frac{1}{x} & \text{for } 0 < x < x_0, \\ 0 & \text{for } x \leq 0. \end{cases}$$

Then $|T'(x)| \leq 2x_0 + 1$, and $T'(x)$ is defined everywhere, though not continuous for $x = 0$, where $T'(x) = f'(x) = 2x \cdot \sin \frac{1}{x} - \cos \frac{1}{x}$ or $0 < x < x_0$ does not have a limit value for $x \rightarrow 0+$. Thus we have constructed a mapping $T \notin C^1$, which satisfies a Lipschitz condition. (It is of course possible to construct far more complicated examples).

4) Assume that there exists an $\alpha > 1$, such that

$$|Tx - Ty| \leq k|x - y|^\alpha.$$

Then

$$0 \leq \left| \lim_{y \rightarrow x} \frac{Tx - Ty}{x - y} \right| \leq \lim_{y \rightarrow x} k \cdot \frac{|x - y|^\alpha}{|x - y|} = k \cdot \lim_{y \rightarrow x} |y - x|^{\alpha-1} = 0.$$

This proves that T is differentiable everywhere of the derivative 0. Then T is a constant.

Example 1.22 Let T be a mapping from a complete metric space (M, d) into itself, and assume that there is a natural number m such that T^m is a contraction. Show that T has one and only one fixed point.

If T^m is a contraction, then T^m has a fixpoint x , thus $T^m x = x$. When we apply T on this equation, we get

$$T^{m+1}x = T^m(Tx) = Tx,$$

hence Tx is also a fixpoint of T^m .

Since T^m is a contraction, the fixpoint is unique, so $Tx = x$, and we have proved that x is a fixpoint for T .

Conversely, if x is a fixpoint for T , then x is also a fixpoint for T^m , because $Tx = x$ implies that

$$T^m x = T^{m-1}(Tx) = T^{m-1}x = \dots = Tx = x.$$

We have assumed that T^m is a contraction, hence the fixpoint for T^m is unique. This is true for every fixpoint x for T , hence it must be unique.

Example 1.23 We consider the metric space \mathbb{R}^k with the metric

$$d_1(x, y) = \sum_{i=1}^k |x_i - y_i|$$

and a mapping $T : \mathbb{R}^k \rightarrow \mathbb{R}^k$ given by $Tx = Cx + b$, where $C = (c_{ij})$ is a $k \times k$ matrix and $b \in \mathbb{R}^k$. Show that T is a contraction, if

$$\sum_{i=1}^k |c_{ij}| < 1 \quad \text{for all } j = 1, 2, \dots, k.$$

If we instead use the metric

$$d_2(x, y) = \sqrt{\sum_{i=1}^k |x_i - y_i|^2},$$

show that T is a contraction if

$$\sum_{i=1}^k \sum_{j=1}^k |c_{ij}|^2 < 1.$$

First note that the i -th coordinate of Tx is

$$(Tx)_i = \sum_{j=1}^k c_{ij}x_j + b_i, \quad i = 1, \dots, k.$$

Put $y = Tx$ and $w = Tz$ and

$$\alpha = \max_{1 \leq j \leq k} \sum_{i=1}^k |c_{ij}| < 1.$$

Then we get the estimates

$$\begin{aligned} d_1(Tx, Tz) &= \sum_{i=1}^k |y_i - w_i| = \sum_{i=1}^k \left| \sum_{j=1}^k c_{ij}(x_j - z_j) \right| \\ &\leq \sum_{i=1}^k \sum_{j=1}^k |c_{ij}| \cdot |x_j - z_j| \leq \alpha \sum_{j=1}^k |x_j - z_j| = \alpha \cdot d_1(x, z), \end{aligned}$$

and the condition $\alpha = \max_{1 \leq j \leq k} |c_{ij}| < 1$ assures that T is a contraction in (\mathbb{R}^k, d_1) .

If instead we consider the metric

$$d_2(x, y) = \sqrt{\sum_{i=1}^k |x_i - y_i|^2},$$

and assume that

$$\alpha^2 = \sum_{i=1}^k \sum_{j=1}^k |c_{ij}|^2 < 1,$$

then we get the following estimate

$$\begin{aligned} \{d_2(x, y)\}^2 &= \sum_{i=1}^k |y_i - w_i|^2 = \sum_{i=1}^k \left| \sum_{j=1}^k c_{ij}(x_j - z_j) \right|^2 \\ &= \sum_{i=1}^k \left| \sum_{j=1}^k c_{ij}(x_j - z_j) \cdot \sum_{\ell=1}^k c_{i\ell}(x_\ell - z_\ell) \right|^2 \\ &\leq \sum_{i=1}^k \sum_{j=1}^k \sum_{\ell=1}^k |c_{ij}| \cdot |x_j - z_j| \cdot |c_{i\ell}| \cdot |x_\ell - z_\ell|. \end{aligned}$$

Trust and responsibility

NNE and Pharmaplan have joined forces to create NNE Pharmaplan, the world's leading engineering and consultancy company focused entirely on the pharma and biotech industries.

Inés Aréizaga Esteva (Spain), 25 years old
Education: Chemical Engineer

– You have to be proactive and open-minded as a newcomer and make it clear to your colleagues what you are able to cope. The pharmaceutical field is new to me. But busy as they are, most of my colleagues find the time to teach me, and they also trust me. Even though it was a bit hard at first, I can feel over time that I am beginning to be taken seriously and that my contribution is appreciated.

Please click the advert



NNE Pharmaplan is the world's leading engineering and consultancy company focused entirely on the pharma and biotech industries. We employ more than 1500 people worldwide and offer global reach and local knowledge along with our all-encompassing list of services.
nnepharmaplan.com

nne pharmaplan®

Then apply

$$|ab| \leq \frac{1}{2} (a^2 + b^2),$$

which follows from the inequality $(|a| - |b|)^2 = a^2 + b^2 - 2|ab| \geq 0$.

If we put

$$a = |c_{i\ell}| \cdot |x_j - z_j| \quad \text{and} \quad b = |c_{ij}| \cdot |x_\ell - z_\ell|,$$

we get

$$\begin{aligned} \{d_2(y, w)\}^2 &= \sum_{i=1}^k \sum_{j=1}^k \sum_{\ell=1}^k \frac{1}{2} \{ |c_{i\ell}|^2 |x_j - z_j|^2 + |c_{ij}|^2 |x_\ell - z_\ell|^2 \} \\ &= \frac{1}{2} \sum_{i=1}^k \sum_{\ell=1}^k |c_{i\ell}|^2 \cdot \sum_{j=1}^k |x_j - z_j|^2 + \frac{1}{2} \sum_{i=1}^k \sum_{j=1}^k k |c_{ij}|^2 \cdot \sum_{\ell=1}^k |x_\ell - z_\ell|^2 \\ &\leq \frac{1}{2} \alpha^2 \{d_2(x, z)\}^2 + \frac{1}{2} \alpha^2 \{d_2(x, z)\}^2 = \alpha^2 \{d_2(x, z)\}^2. \end{aligned}$$

Since $\alpha^2 < 1$, and hence also $0 \leq \alpha < 1$, and

$$d_2(y, w) = d_2(Tx, Tz) \leq \alpha \cdot d_2(x, z),$$

we conclude that T is a contraction in (\mathbb{R}^k, d_2) .

Example 1.24 *In connection with Banach's Fixpoint Theorem, the inequality*

$$d(x, x_n) \leq \frac{\alpha}{1 - \alpha} d(x_{n-1}, x_n)$$

is often mentioned. Prove this inequality.

Given that $\alpha \in]0, 1[$, at $Tx_n = x_{n+1}$, and $x_n \rightarrow x$.

Choose to any $\varepsilon \in \mathbb{R}_+$ an N , such that we for all $p \geq N$ have $d(x, x_p) < \varepsilon$. If $p \geq N$ and $p \geq n + 1$, then

$$\begin{aligned} d(x, x_n) &\leq d(x, x_p) + d(x_p, x_n) < \varepsilon + d(x_p, x_n) \\ &\leq \varepsilon + d(x_p, x_{p-1}) + d(x_{p-1}, x_{p-2}) + \cdots + d(x_{n+1}, x_n) \\ &= \varepsilon + d(Tx_{p-1}, Tx_{p-2}) + d(Tx_{p-2}, Tx_{p-3}) + \cdots + d(Tx_n, Tx_{n-1}) \\ &\leq \varepsilon + \alpha \cdot \frac{1 - \alpha^{p-n}}{1 - \alpha} \cdot d(x_{n-1}, x_n) \\ &\leq \varepsilon + \frac{\alpha}{1 - \alpha} \cdot d(x_{n-1}, x_n). \end{aligned}$$

This is true for every $\varepsilon > 0$, thus

$$d(x, x_n) \leq \frac{\alpha}{1 - \alpha} \cdot d(x_{n-1}, x_n).$$

Example 1.25 Consider the matrix equation $Ax + b = 0$, where $A = (a_{ij})_{i,j=1}^k$ (and the a_{ij} real). Put $A = C - I$ and rewrite the equation as $x = Cx + b$.

If

$$(5) \sum_{j=1}^k |c_{ij}| < 1 \quad \text{for } i = 1, 2, \dots, k,$$

then there is a unique solution x , which can be found by iteration.

Prove that the condition (5) can be formulated as the following condition of the a_{ij} ,

$$a_{ii} < 0, \quad |a_{ii}| > \sum_{j=1, j \neq i}^k |a_{ij}|, \quad |a_{ii}| < 2 - \sum_{j=1, j \neq i}^k |a_{ij}|,$$

for $i = 1, 2, \dots, k$.

We have $a_{ij} = c_{ij} - \delta_{ij}$, thus $c_{ij} = \delta_{ij} + a_{ij}$. In particular, $c_{ii} = 1 + a_{ii}$. Since

$$\sum_{j=1}^k |c_{ij}| < 1,$$

we have $|c_{ii}| < 1$, thus $a_{ii} \in]-2, 0[$.

Furthermore, $c_{ij} = |a_{ij}|$ for $i \neq j$, so

$$\sum_{j=1}^k |c_{ij}| = \sum_{j=1, j \neq i}^k |a_{ij}| + |1 + a_{ii}| < 1.$$

It follows that

$$\sum_{j=1}^k |a_{ij}| < 1 - |1 + a_{ii}| = 1 - |1 - |a_{ii}|| \leq 1.$$

If

$$|a_{ii}| \leq 1 \quad \left(< 2 - \sum_{j=1, j \neq i}^k |a_{ij}| \right),$$

then

$$\sum_{j=1, j \neq i}^k |a_{ij}| < 1 - 1 + |a_{ii}| = |a_{ii}|.$$

If

$$|a_{ii}| > 1 \quad \left(> \sum_{j=1, j \neq i}^k |a_{ij}| \right),$$

then

$$\sum_{j=1, j \neq i}^k |a_{ij}| < 1 - |a_{ii}| + 1 = 2 - |a_{ii}|,$$

hence by a rearrangement,

$$|a_{ii}| < 2 - \sum_{j=1, j \neq i}^k |a_{ij}|,$$

and we derive in both cases that

$$\sum_{j=1, j \neq i}^k |a_{ij}| < |a_{ii}| < 2 - \sum_{j=1, j \neq i}^k |a_{ij}|.$$

Conversely, assume that $a_{ii} < 0$ and that

$$\sum_{j=1, j \neq i}^k |a_{ij}| < |a_{ii}| < 2 - \sum_{j=1, j \neq i}^k |a_{ij}|.$$

Then

$$\sum_{j=1, j \neq i}^k |a_{ij}| < 1.$$

If $|a_{ii}| \leq 1$, then

$$|a_{ii}| = 1 - 1 + |a_{ii}| = 1 - |1 - |a_{ii}|| = 1 - |1 + a_{ii}| = 1 - |c_{ii}|,$$

thus

$$\sum_{j=1, j \neq i}^k |a_{ij}| = \sum_{j=1, j \neq i}^k |c_{ij}| < 1 - |c_{ii}|,$$

and hence

$$\sum_{j=1}^k |c_{ij}| < 1.$$

If $|a_{ii}| > 1$, then

$$|a_{ii}| = 1 - 1 + |a_{ii}| = 1 + ||a_{ii}| - 1| = 1 + |a_{ii} + 1| = 1 + |c_{ii}|,$$

hence by insertion

$$1 + |c_{ii}| < 2 - \sum_{j=1, j \neq i}^k |a_{ijn}| = 2 - \sum_{j=1, j \neq i}^k |c_{ij}|,$$

follows by a rearrangement

$$\sum_{j=1}^k |c_{ij}| < 1.$$

1.4 Simple integral equations

Example 1.26 Consider the Volterra integral equation:

$$x(t) - \mu \int_a^t k(t, s)x(s) ds = v(t), \quad t \in [a, b],$$

where $v \in C([a, b])$, $k \in C([a, b]^2)$ and $\mu \in \mathbb{C}$.

Show that the equation has a unique solution $x \in C([a, b])$ for any $\mu \in \mathbb{C}$.

HINT: Write the equation $x = Tx$ where

$$Tx = v(t) + \mu \int_a^t k(t, s)x(s) ds.$$

Take $x_0 \in C([a, b])$ and define the iteration by $x_{n+1} = Tx_n$, then show by induction that

$$|T^m x(t) - T^m y(t)| \leq |\mu|^m c^m \frac{(t-a)^m}{m!} d_\infty(x, y),$$

where $c = \max |k|$. Then show (by looking at $d_\infty(T^m x, T^m y)$) that T^m is a contraction for some m and argue that T then must have a unique fixed point in the metric space $(C([a, b]), d_\infty)$.

Using the given definition of T we see that the equation is equivalent with $Tx = x$. Then

$$\begin{aligned} |Tx(t) - Ty(t)| &= |\mu| \cdot \left| \int_a^t k(t, s)x(s) ds - \int_a^t k(t, s)y(s) ds \right| = |\mu| \cdot \left| \int_a^t k(t, s) \cdot \{x(s) - y(s)\} ds \right| \\ &\leq |\mu| \cdot c \cdot d_\infty(x - y) \cdot \left| \int_a^t 1 ds \right| = |\mu|^1 \cdot c^1 \cdot \frac{(t-a)^1}{1!} d_\infty(x, y), \end{aligned}$$

which shows that the inequality above holds for $m = 1$.

Assume that for some $m \in \mathbb{N}$,

$$(6) \quad |T^m x(t) - T^m y(t)| \leq |\mu|^m c^m \cdot \frac{(t-a)^m}{m!} d_\infty(x, y).$$

Then

$$\begin{aligned} |T^{m+1} x(t) - T^{m+1} y(t)| &= |\mu| \cdot \left| \int_a^t k(t, s)\{T^m x(s) - T^m y(s)\} ds \right| \\ &\leq |\mu| \cdot c \int_a^t |T^m x(s) - T^m y(s)| ds \\ &\leq |\mu| \cdot c \cdot |\mu|^m \cdot c^m \cdot d_\infty(x, y) \cdot \int_a^t \frac{(s-a)^m}{m!} ds \\ &= |\mu|^{m+1} c^{m+1} \cdot d_\infty(x, y) \cdot \left[\frac{(s-a)^{m+1}}{(m+1)!} \right]_a^t \\ &= |\mu|^{m+1} c^{m+1} \cdot \frac{(t-a)^{m+1}}{(m+1)!} \cdot d_\infty(x, y), \end{aligned}$$

and (6) follows by induction for all $m \in \mathbb{N}$.

We infer from (6) that

$$d_\infty(T^m x, T^m y) \leq |\mu|^m c^m \cdot \frac{(b-a)^m}{m!} \cdot d_\infty(x, y).$$

Now

$$\sum_{m=0}^{\infty} |\mu|^m c^m \cdot \frac{(b-a)^m}{m!} = \exp(|\mu| \cdot c \cdot (b-a))$$

is convergent, thus

$$|\mu|^m c^m \cdot \frac{(b-a)^m}{m!} \rightarrow 0 \quad \text{for } m \rightarrow \infty.$$

There exists in particular an $M \in \mathbb{N}$, such that

$$\alpha = |\mu|^m c^m \cdot \frac{(b-a)^m}{m!} < 1 \quad \text{for all } m \geq M.$$

Thus, if $m \geq M$, then T^m is a contraction, and T^m has a fixpoint x . An application of EXAMPLE 1.22 shows that x is also a fixpoint for T , and x is the unique fixpoint of T .

Let $x_0 \in C^0([a, b])$. Define by iteration $x_{m+1} = Tx_m$. Then $x_m = T^m x_0$. The sequence $(x_{m \cdot n})$ converges towards x . The same does the sequence (x_{mn+j}) , where $j = 0, 1, \dots, m-1$, because

$$x_{mn+j} = T^{mn} (T^j x_0) = T^{mn+j} x_0.$$

Summing up we conclude that (x_n) itself converges towards x , and the claim is proved.

Please click the advert

MILKROUND SYSTEM
Become a business star with internships, placements, graduate jobs & schemes from leading companies.
www.milkround.com

PLANET CAREER ADVICE
Inhabited by insights into business careers and orbited by application advice.

FIRST CONTACT
Get matched to top business employers via intelligent emails landing in your inbox.

Milkround.com: rated the #1 graduate recruitment website in the UK Graduate Careers Survey 2009 of 16,000 university finalists.

Example 1.27 Solve by iteration the equation

$$f(t) = u(t) = \frac{1}{2} \int_0^1 e^{t-s} f(s) ds, \quad t \in [0, 1],$$

(where u is a given continuous function), by choosing f_0 as u .
Find in particular the solutions in the cases

$$u(t) = 1, \quad u(t) = t.$$

Then solve the equation directly (without using iteration), assuming that $u \in C^1([0, 1])$.

If we put $f_0(t) = u(t)$, then

$$f_1(t) = u(t) + \frac{1}{2} \int_0^1 e^{t-s} u(s) ds = u(t) + \frac{1}{2} \left\{ \int_0^1 e^{-s} u(s) ds \right\} \cdot e^t.$$

Putting $a = \int_0^1 e^{-s} u(s) ds$, we get

$$f(t) = u(t) + \frac{a}{2} e^t.$$

It follows that

$$\begin{aligned} f_2(t) &= u(t) + \frac{1}{2} \int_0^1 e^{t-s} f_1(s) ds = u(t) + \frac{1}{2} e^t \left\{ \int_0^1 e^{-s} u(s) ds + \frac{a}{2} \int_0^1 e^{-s} e^s ds \right\} \\ &= u(t) + e^t \left\{ \frac{a}{2} + \frac{a}{4} \right\} = u(t) + \frac{3}{4} a \cdot e^t. \end{aligned}$$

We conclude from the structure

$$f(t) = u(t) + e^t \left\{ \frac{1}{2} \int_0^1 e^{-s} f(s) ds \right\},$$

that a solution must have the form $f(t) = u(t) + c \cdot e^t$. We therefore guess that the n -th iteration may be written

$$f_n(t) = u(t) + a \cdot k_n e^t.$$

We get by insertion

$$\begin{aligned} f_{n+1}(t) &= u(t) + \frac{1}{2} \int_0^1 e^{t-s} f_n(s) ds \\ &= u(t) + \frac{1}{2} e^t \left\{ \int_0^1 e^{-s} u(s) ds + a \cdot k_n \int_0^1 e^{-s} e^s ds \right\} \\ &= u(t) + \frac{1}{2} a e^t \left\{ \frac{1}{2} e^t \cdot a \cdot k_n \right\} = u(t) + a \left\{ \frac{1+k_n}{2} \right\} e^t, \end{aligned}$$

and conclude that

$$k_{n+1} = \frac{1}{2} (1 + k_n).$$

If $k_n \in [0, 1[$, then it follows that $k_n < k_{n+1} < 1$, thus (k_n) is increasing and bounded. (Notice that $k_1 = \frac{1}{2}$), thus it is convergent of the limit value k . We conclude from the equation of recursions that $k = \frac{1}{2}(1 + k)$, thus $k = 1$. Hence the solution is given by

$$f(t) = u(t) + e^t \int_0^1 e^{-s} u(s) ds.$$

CHECK. We get by insertion,

$$u(t) + \frac{1}{2} \int_0^1 e^{t-s} f(s) ds = u(t) + \frac{1}{2} e^t \int_0^1 e^{-s} u(s) ds + \frac{1}{2} e^t \int_0^1 e^{-s} u(s) ds = f(t),$$

proving that we have found a solution. \diamond

If $u(t) = 1$, then

$$f(t) = 1 + e^t \int_0^1 e^{-s} ds = 1 + e^t [-e^{-s}]_0^1 = 1 + \left(1 - \frac{1}{e}\right) e^t.$$

If $u(t) = t$, then

$$f(t) = t + e^t \int_0^1 s e^{-s} ds = t + e^t [-s e^{-s} - e^{-s}]_0^1 = t + \left(1 - \frac{2}{e}\right) e^t.$$

As mentioned above the solution must have the form $u(t) + c \cdot e^t$. Then by insertion,

$$\begin{aligned} u(t) + \frac{1}{2} \int_0^1 e^{t-s} f(s) ds &= u(t) + \frac{1}{2} \int_0^1 e^{t-s} \{u(s) + c \cdot e^s\} ds \\ &= u(t) + \frac{1}{2} \left\{ \int_0^1 e^{-s} u(s) ds + c \right\} e^t = u(t) + c \cdot e^t = f(t), \end{aligned}$$

and we conclude that $c = \int_0^1 e^{-s} u(s) ds$.

If $u \in C^1([0, 1])$, then

$$f(t) = u(t) + \left\{ \frac{1}{2} \int_0^1 e^{-s} f(s) ds \right\} \cdot e^t \in C^1,$$

so we can ALTERNATIVELY solve the equation by differentiation with respect to t . It follows from

$$\frac{1}{2} \int_0^1 e^{t-s} f(s) ds = f(t) - u(t),$$

that

$$f'(t) = u'(t) + \frac{1}{2} \int_0^1 e^{t-s} f(s) ds = f(t) + u'(t) - u(t),$$

hence by a multiplication by e^{-t} follows by a rearrangement,

$$f'(t) e^{-t} - f(t) e^{-t} = \frac{d}{dt} \{e^{-t} f(t)\} = u'(t) e^{-t} - u(t) e^{-t} = \frac{d}{dt} \{e^{-t} u(t)\},$$

and we get by an integration

$$e^{-t}f(t) = e^{-t}u(t) + c,$$

hence

$$f(t) = u(t) + c \cdot e^t.$$

The constant c is determined as above. The latter variant is of course not the shortest one.

Please click the advert



CHALLENGE YOURSELF

WWW.STUDYINSWEDEN.SE

Today's job market values ambitious, innovative, perceptive team players. Swedish universities foster these qualities through a forward-thinking culture where you're close to the latest ideas and global trends.

Whatever your career goals may be, studying in Sweden will give you valuable skills and a competitive advantage for your future. www.studyinsweden.se

Si.
Swedish Institute

Download free books at BookBooN.com

Example 1.28 Let $C^0([a, b])$ be equipped with the metric

$$d(x, y) = \max_{t \in [a, b]} |x(t) - y(t)|.$$

We define an operator (a mapping) S by

$$Sx(t) = \int_a^b k(t, s)x(s) ds,$$

where k is a continuous function on $[a, b] \times [a, b]$. Let (x_n) be inductively given by

$$(7) \quad x_{n+1} = u + \mu Sx_n,$$

and put $z_n = x_n - x_{n-1}$. Prove that (7) equivalently can be written

$$(8) \quad z_{n+1} = \mu Sz_n.$$

Put $x_0 = u$, and prove that (7) implies the Neumann series

$$x = \lim_{n \rightarrow \infty} x_n = u + \mu Su + \mu^2 S^2 u + \cdots .$$

We note that

$$x_{n+1}(t) = u(t) + \mu \int_a^b k(t, s)x_n(s) ds = u(t) + \mu Sx_n(t).$$

Putting $z_n = x_n - x_{n-1}$, we get

$$\begin{aligned} z_{n+1} &= x_{n+1} - x_n = u + \mu Sx_n - u - \mu Sx_{n-1} \\ &= \mu S(x_n - x_{n-1}) = \mu Sz_n. \end{aligned}$$

If $|\mu| < \frac{1}{(b-a)c}$, then $x_n \rightarrow x$. It follows from

$$x_n = x_n - x_{n-1} + x_{n-1} - x_{n-2} + x_{n-2} + \cdots + x_1 - x_0 + x_0 = x_0 + z_1 + \cdots + z_n,$$

and

$$z_n = \mu Sz_{n-1} = \cdots = \mu^n S^n x_0,$$

that $\sum_n z_n$ is convergent, and we have

$$x = \lim_{n \rightarrow \infty} x_n = u + \mu Su + \mu^2 S^2 u + \cdots .$$

Example 1.29 *Solve*

$$x(t) - \mu \int_0^1 x(s) ds = 1$$

by means of the Neumann series, where we assume that $|\mu| < 1$. Try also to solve the equation directly.

In this case, $u(t) = 1$ and $k(t, s) = 1$, $a = 0$ and $b = 1$, thus $|\mu| < 1$ is a reasonable requirement (cf. EXAMPLE 1.28). It follows from EXAMPLE 1.28 that

$$x = 1 + \mu S + \mu^2 S^2 1 + \dots$$

We get from $S1 = \int_0^1 1 ds = 1$, that $S^2 1 = 1$. Then by induction, $S^n 1 = 1$, hence

$$x = 1 + \mu + \mu^2 + \dots = \frac{1}{1 - \mu}.$$

We now solve the equation directly. It follows from the rearrangement

$$x(t) = 1 + \mu \int_0^1 x(s) ds$$

that $x(t) = a$ must be a constant. Then by insertion,

$$a = 1 + \mu \cdot a,$$

hence

$$x(t) = a = \frac{1}{1 - \mu},$$

which apparently holds for every $\mu \neq 1$, and not just for $|\mu| < 1$.

2 Banach spaces

2.1 Simple vector spaces

Example 2.1 In the vector space $C([a, b])$ we consider the functions

$$e_0(t), e_1(t), \dots, e_n(t),$$

where $e_j(t)$ is a polynomial of degree j , where $j = 0, 1, \dots, n$,
 Show that e_0, e_1, \dots, e_n are linearly independent.

Since $e_0(t) = e_0 \neq 0$, we infer from $a_0 e_0 = 0$ that $a_0 = 0$, and the claim is true for $k = 0$.

First let $e_k(t) = t^k$, and assume that the claim is true for $k = 0, 1, \dots, n$. Now let

$$a_0 + a_1 t + \dots + a_n t^n + a_{n+1} t^{n+1} \equiv 0 \quad \text{for } t \in [a, b].$$

We get by a differentiation,

$$a_1 + 2a_2 t + \dots + na_n t^{n-1} + (n+1)a_{n+1} t^n \equiv 0 \quad \text{for } t \in [a, b],$$

thus $ka_k = 0, k = 1, 2, \dots, n+1$, according to the assumption of induction. We conclude that $a_k = 0$ for $k = 1, 2, \dots, n+1$, which by insertion gives the condition $a_0 = 0$. Then it follows by induction that $\{t^n \mid n \in \mathbb{N}_0\}$ are linearly independent.

Then let

$$e_k(t) = \sum_{j=0}^k e_{kj} t^j, \quad e_{kk} \neq 0,$$

and assume that

$$0 \equiv \sum_{k=0}^n a_k e_k(t) = \sum_{k=0}^n \sum_{j=0}^k a_k e_{kj} t^j = \sum_{j=0}^n \left\{ \sum_{k=j}^n a_k e_{kj} \right\} t^j.$$

It follows from the result above that

$$\sum_{k=j}^n a_k e_{kj} = 0 \quad \text{for } j = 0, 1, \dots, n.$$

We get for $j = n$ that $a_n e_{nn} = 0$, and since $e_{nn} \neq 0$, we must have $a_n = 0$. Since $e_{k,k+j} = 0$ for $j \geq 1$, the equation is reduced to

$$0 \equiv \sum_{j=0}^n \left\{ \sum_{k=j}^n a_k e_{kj} \right\} t^j = \sum_{j=0}^n \left\{ \sum_{k=j}^{n-1} a_k e_{kj} \right\} t^j = \sum_{j=0}^{n-1} \left\{ \sum_{k=j}^{n-1} a_k e_{kj} \right\} t^j,$$

where we as before conclude that $a_{n-1} = 0$. Then by recursion,

$$a_{n-2} = \dots = a_1 = a_0 = 0.$$

Example 2.2 Let U_1 and U_2 be subspaces of the vector space V . Show that $U_1 \cap U_2$ is a subspace. Is $U_1 \cup U_2$ always a subspace? If no, state conditions such that $U_1 \cup U_2$ is a subspace.

If U_1 and U_2 are subspaces, then

$$\forall \lambda \forall u, v \in U_i : u + \lambda v \in U_i, \quad i = 1, 2.$$

If $u, v \in U_1 \cap U_2$, then in particular, $u, v \in U_i, i = 1, 2$, thus $u + \lambda v \in U_i, i = 1, 2$, according to the above. It follows that $u + \lambda v \in U_1 \cap U_2$, hence $U_1 \cap U_2$ is also a subspace.

On the other hand, $U_1 \cup U_2$ is rarely a subspace. E.g. the X -axis and the Y -axis are two subspaces in \mathbb{R}^2 , and it is obvious that the union of the two axes is not a subspace.

The condition is that $U_1 \subseteq U_2$, or $U_1 \supseteq U_2$. In fact, if one of these conditions is satisfied, then it is obvious that $U_1 \cup U_2 = U_i$, where i is one of the numbers 1, 2.

If this condition is not fulfilled, then there exist

$$u_1 \in U_1 \setminus U_2 \quad \text{and} \quad u_2 \in U_2 \setminus U_1.$$

Assume that $u_1 + u_2 \in U_1 \cup U_2$, e.g. $u_1 + u_2 \in U_1$. Then $u_2 = (u_1 + u_2) - u_1 \in U_1$ contradicting the assumption. Hence we conclude that $u_1 + u_2 \notin U_1 \cup U_2$, and $U_1 \cup U_2$ is not a subspace.

Please click the advert



DIVERSE - INNOVATIVE - INTERNATIONAL

Are you considering a European business degree?

Copenhagen Business School is one of the largest business schools in Northern Europe with more than 15,000 students from Europe, North America, Australia and Asia.

Are you curious to know how a modern European business school competes with a diverse, innovative and international study environment?

Please visit Copenhagen Business School at www.cbs.dk



Copenhagen Business School
HANDELSHØJSKOLEN

Diversity creating knowledge



Example 2.3 Let V denote the set of all real $n \times n$ matrices.
 Show that V with the usual scalar multiplication and addition is a vector space.
 Is the set of all regular $n \times n$ -matrices a subspace of V ?
 Is the set of all symmetric $n \times n$ matrices a subspace of V ?

The first question is trivial: Since 0 is the zero element, and since 0 is not regular, the set of all regular matrices is not a subspace.

The set of all symmetric matrices is of course a subspace. In fact, if (a_{ij}) and (b_{ij}) are symmetric, thus $a_{ij} = a_{ji}$ and $b_{ij} = b_{ji}$, then

$$\lambda(a_{ij}) + (b_{ij}) = (\lambda a_{ij} + b_{ij}),$$

where

$$\lambda a_{ij} + b_{ij} = \lambda a_{ji} + b_{ji},$$

hence $(\lambda a_{ij} + b_{ij})$ is again symmetric.

Example 2.4 In the space $C([a, b])$ we consider the sets

$U_1 =$ the set of polynomials defined on $[a, b]$.

$U_2 =$ the set of polynomials defined on $[a, b]$ of degree $\leq n$.

$U_3 =$ the set of polynomials defined on $[a, b]$ of degree $= n$.

$U_4 =$ the set of all $f \in C([a, b])$ with $f(a) = f(b) = 0$.

$U_5 = C^1([a, b])$.

Which of the U_i , $i = 1, 2, \dots, 5$, are subspaces of $C([a, b])$?

$U_1 =$ the set of all polynomials is a subspace.

$U_2 =$ the set of all polynomials of degree $\leq n$ is a subspace.

$U_3 =$ the set of all polynomials of degree $= n$ is not a subspace. E.g. 0 does not belong to U_3 .

$U_4 =$ the set of all $f \in C^0([a, b])$ with $f(a) = f(b) = 0$ is a subspace.

$U_5 = C^1([a, b])$ is a subspace.

Example 2.5 In $C([-1, 1])$ we consider the sets U_1 and U_2 consisting of the odd and even functions in $C([-1, 1])$, respectively.

Show that U_1 and U_2 are subspaces and that $U_1 \cap U_2 = \{0\}$.

Show that every $f \in C([-1, 1])$ can be written in the form $f = f_1 + f_2$, where $f_1 \in U_1$ and $f_2 \in U_2$, and that this decomposition is unique.

If f, g are odd (even) functions, then $f + \lambda g$ is again an odd (even) function. Hence U_1 and U_2 are subspaces.

If $f \in U_1 \cap U_2$, then both

$$f(-t) = f(t) \quad \text{and} \quad f(-t) = -f(t),$$

thus $f(t) = -f(t)$ for all t , and we conclude that $2f(t) \equiv 0$. We conclude that $f \equiv 0$.

We see from

$$f(t) = \frac{f(t) + f(-t)}{2} + \frac{f(t) - f(-t)}{2},$$

where

$$\frac{f(t) + f(-t)}{2} \text{ is even, and } \frac{f(t) - f(-t)}{2} \text{ is odd,}$$

that such a splitting exists.

Assume that

$$f(t) = f_1(t) + f_2(t) = g_1(t) + g_2(t),$$

where f_1 and g_1 are odd, while f_2 and g_2 are even. Then

$$f_1(t) - g_1(t) = g_2(t) - f_2(t) \in U_1 \cap U_2 = \{0\},$$

hence $f_1 - g_1 = 0$ and $g_2 - f_2 = 0$. We conclude that $f_1 = g_1$ and $f_2 = g_2$, and the splitting is unique.

2.2 Normed spaces

Example 2.6 In the space $C^1([a, b])$ we have the norm

$$\|f\|_\infty = \sup_{t \in [a, b]} |f(t)|.$$

Show that we could take $\sup_{t \in (a, b)} |f(t)|$ instead.

Show that $C^1([a, b])$ with the sup-norm is not a Banach space.

Show that

$$\|f\|_\infty^* = \sup_{t \in [a, b]} |f(t)| + \sup_{t \in [a, b]} |f'(t)|$$

is also a norm on $C^1([a, b])$ and that it is a Banach space with this norm.

Every $f \in C^1([a, b])$ is continuous, so

$$\sup_{t \in [a, b]} |f(t)| = \sup_{t \in (a, b)} |f(t)|,$$

and we can use any of the two sup-norms.

It follows from Weierstraß's Approximation Theorem that the set \mathcal{P} of polynomials on $[a, b]$ is dense in $C^0([a, b])$ in the uniform norm. Since

$$\mathcal{P} \subset C^1([a, b]) \subset C^0([a, b])$$

and $C^1([a, b]) \neq C^0([a, b])$, we infer that $C^1([a, b])$ cannot be complete, thus $(C^1([a, b]), \|\cdot\|)$ is not a Banach space.

Then we shall prove that $\|\cdot\|_\infty^*$ is a norm.

1) Clearly, $\|f\|_\infty^* \geq 0$.

2) If

$$\|f\|_\infty^* = \sup_{t \in [a, b]} |f(t)| + \sup_{t \in [a, b]} |f'(t)| = \|f\|_\infty + \|f'\|_\infty = 0,$$

then in particular $\|f\| = 0$, so $f = 0$, because f is continuous.

3)

$$\|\lambda f\|_\infty^* = \|\lambda f\|_\infty + \|\lambda f'\|_\infty = |\lambda|(\|f\|_\infty + \|f'\|_\infty) = |\lambda| \cdot \|f\|_\infty^*.$$

4)

$$\begin{aligned} \|f + g\|_\infty^* &= \|f + g\|_\infty + \|f' + g'\|_\infty \leq \|f\|_\infty + \|g\|_\infty + \|f'\|_\infty + \|g'\|_\infty \\ &= (\|f\|_\infty + \|f'\|_\infty) + (\|g\|_\infty + \|g'\|_\infty) = \|f\|_\infty^* + \|g\|_\infty^*. \end{aligned}$$

We have proved that $\|\cdot\|_\infty^*$ is a norm on $C^1([a, b])$.

It “only” remains to prove that $(C^1([a, b]), \|\cdot\|_\infty^*)$ is a Banach space. Let (f_n) be a Cauchy sequence, i.d.

$$\forall \varepsilon > 0 \exists N \in \mathbb{N} \forall m, n \in \mathbb{N} : m, n \geq N \implies \|f_m - f_n\|_\infty^* < \varepsilon.$$

It follows from $\|f\|_\infty^* = \|f\|_\infty + \|f'\|_\infty$, that $\|f\|_\infty \leq \|f\|_\infty^*$ and $\|f'\|_\infty \leq \|f\|_\infty^*$, thus (f_n) and (f'_n) are Cauchy sequences in the Banach space $(C^0([a, b]), \|\cdot\|_\infty)$. Hence there are continuous functions $f, g \in C^0([a, b])$, such that

$$f_n \rightarrow f \quad \text{and} \quad f'_n \rightarrow g.$$

Notice that it is not possible from this directly to conclude that

$$a) f \in C^1([a, b]), \quad b) f' = g.$$

A proof is required:

Define a function $h \in C^1([a, b])$ by

$$h(x) = \int_a^x g(t) dt + f(a), \quad x \in [a, b].$$

Please click the advert



Sharp Minds - Bright Ideas!

Employees at FOSS Analytical A/S are living proof of the company value - First - using new inventions to make dedicated solutions for our customers. With sharp minds and cross functional teamwork, we constantly strive to develop new unique products - Would you like to join our team?

FOSS works diligently with innovation and development as basis for its growth. It is reflected in the fact that more than 200 of the 1200 employees in FOSS work with Research & Development in Scandinavia and USA. Engineers at FOSS work in production, development and marketing, within a wide range of different fields, i.e. Chemistry, Electronics, Mechanics, Software, Optics, Microbiology, Chemometrics.

We offer
A challenging job in an international and innovative company that is leading in its field. You will get the opportunity to work with the most advanced technology together with highly skilled colleagues.

Read more about FOSS at www.foss.dk - or go directly to our student site www.foss.dk/sharpminds where you can learn more about your possibilities of working together with us on projects, your thesis etc.

Dedicated Analytical Solutions

FOSS
 Slangerupgade 69
 3400 Hillerød
 Tel. +45 70103370
www.foss.dk

The Family owned FOSS group is the world leader as supplier of dedicated, high-tech analytical solutions which measure and control the quality and production of agricultural, food, pharmaceutical and chemical products. Main activities are initiated from Denmark, Sweden and USA with headquarters domiciled in Hillerød, DK. The products are marketed globally by 23 sales companies and an extensive net of distributors. In line with the corevalue to be 'First', the company intends to expand its market position.







We shall prove that $h(x) = f(x)$. It suffices to prove that $f_n \rightarrow h$ uniformly, because the limit function $f \in C^0([a, b])$ is unique. From $f_n \in C^1([a, b])$ follows that

$$f_n(x) = \int_a^x f'_n(t) dt + f_n(a), \quad x \in [a, b],$$

hence for every $x \in [a, b]$,

$$\begin{aligned} |f_n(x) - h(x)| &= \left| \int_a^x f'_n(t) dt + f_n(a) - \int_a^x g(t) dt - f(a) \right| \\ &\leq \left| \int_a^x \{f'_n(t) - g(t)\} dt \right| + |f_n(a) - f(a)|. \end{aligned}$$

Let $\varepsilon > 0$ be given. Since $f_n(a) \rightarrow f(a)$, and $f'_n \rightarrow g$ uniformly for $n \rightarrow +\infty$, there exists an $n_0 \in \mathbb{N}$, such that for every $n \geq n_0$,

$$|f_n(a) - f(a)| < \frac{\varepsilon}{2} \quad \text{and} \quad \sup_{t \in [a, b]} |f'_n(t) - g(t)| < \frac{\varepsilon}{2(b-a)}.$$

Therefore, if $n \geq n_0$, then for every $x \in [a, b]$,

$$|f_n(x) - h(x)| < \left| \int_a^x \frac{\varepsilon}{2(b-a)} dt \right| + \frac{\varepsilon}{2} \leq \frac{\varepsilon}{2} + \frac{\varepsilon}{2} = \varepsilon,$$

thus

$$\|f_n - h\|_\infty < \varepsilon \quad \text{for all } n \geq n_0,$$

and we have proved that $f_n \rightarrow h$ uniformly, hence $f = h$. Finally, since $h' = g$, the claim is proved.

Example 2.7 Let $f \in C([a, b])$ and consider the p -norms

$$\|f\|_p = \left\{ \int_a^b |f(t)|^p dt \right\}^{\frac{1}{p}}, \quad p \geq 1,$$

and

$$\|f\|_\infty = \sup_{t \in [a, b]} |f(t)|.$$

Show that $\|f\|_p \rightarrow \|f\|_\infty$ for $p \rightarrow \infty$.

The interval $[a, b]$ is bounded, so

$$\|f\|_p = \left\{ \int_a^b |f(t)|^p dt \right\}^{\frac{1}{p}} \leq \left\{ \int_a^b \|f\|_\infty^p dt \right\}^{\frac{1}{p}} = \|f\|_\infty (b-a)^{\frac{1}{p}}.$$

The function f is continuous and $[a, b]$ is compact, hence there exists a $t_0 \in [a, b]$, such that

$$|f(t_0)| = \|f\|_\infty.$$

To every $\varepsilon > 0$ we can find an interval $[c_\varepsilon, d_\varepsilon] \subseteq [a, b]$, $c_\varepsilon < d_\varepsilon$ (independently of p), such that

$$|f(t)| \geq (1 - \varepsilon)\|f\|_\infty \quad \text{for all } t \in [c_\varepsilon, d_\varepsilon].$$

Then we get the estimate

$$\begin{aligned} \|f\|_p &= \left\{ \int_a^b |f(t)|^p dt \right\}^{\frac{1}{p}} \geq \left\{ \int_{c_\varepsilon}^{d_\varepsilon} |f(t)|^p dt \right\}^{\frac{1}{p}} \geq \left\{ (1 - \varepsilon)^p \|f\|_\infty^p \int_{c_\varepsilon}^{d_\varepsilon} dt \right\}^{\frac{1}{p}} \\ &= (1 - \varepsilon)\|f\|_\infty \cdot (d_\varepsilon - c_\varepsilon)^{\frac{1}{p}}. \end{aligned}$$

Summing up we get for every $\varepsilon > 0$ that

$$(1 - \varepsilon)\|f\|_\infty \cdot (d_\varepsilon - c_\varepsilon)^{\frac{1}{p}} \leq \|f\|_p \leq \|f\|_\infty \cdot (b - a)^{\frac{1}{p}}.$$

If $k > 0$ is kept fixed, we have $k^{\frac{1}{p}} \rightarrow 1$ for $p \rightarrow \infty$. To every $\varepsilon > 0$ there exists a $P_\varepsilon > 0$, such that for every $p \geq P_\varepsilon$,

$$(d_\varepsilon - c_\varepsilon)^{\frac{1}{p}} \geq 1 - \varepsilon \quad \text{and} \quad (b - a)^{\frac{1}{p}} \leq 1 + \varepsilon,$$

hence

$$(1 - \varepsilon)^2 \|f\|_\infty \leq \|f\|_p \leq (1 + \varepsilon)\|f\|_\infty \quad \text{for every } p \geq P_\varepsilon.$$

This proves that $\lim_{p \rightarrow +\infty} \|f\|_p$ exists and that

$$\lim_{p \rightarrow +\infty} \|f\|_p = \|f\|_\infty.$$

Example 2.8 Let V be a normed vector space and let x_1, \dots, x_k be k linearly independent vectors from V . Show that there exists a positive constant m , such that for all scalars $\alpha_i \in \mathbb{C}$, $i = 1, \dots, k$, we have

$$\|\alpha_1 x_1 + \dots + \alpha_k x_k\| \geq m(|\alpha_1| + \dots + |\alpha_k|).$$

Indirect proof. We assume that there exists a sequence (y_m) , where

$$y_m = \sum_{i=1}^k \beta_i^{(m)} x_i, \quad \text{where } \sum_{i=1}^k |\beta_i^{(m)}| = 1 \text{ for all } m \in \mathbb{N},$$

and where $\|y_m\| \rightarrow 0$ for $m \rightarrow +\infty$. Under these assumptions we first notice that $|\beta_i^{(m)}| \leq 1$, such that $\left(\beta_i^{(m)}\right)_{m=1}^{+\infty}$ is a bounded sequence of complex numbers. The complex numbers \mathbb{C} being complete in the absolute value, there exists a convergent subsequence

$$\left(\beta_1^{(m_j)}\right)_{j=1}^{+\infty} \quad \text{af} \quad \left(\beta_1^{(m)}\right).$$

The trick is first to thin out $(\beta_2^{(m)})$ to the subsequence $\left(\beta_1^{(m_j)}\right)$, where (m_j) is given above.

Then thin it out once more to get a convergent subsequence

$$\left(\beta_2^{(m_j^2)}\right) \quad \text{of} \quad \left(\beta_2^{(m_j^1)}\right).$$

Because (m_j^2) is a subsequence of (m_j^1) , the subsequence $\left(\beta_1^{(m_j^2)}\right)$ is also convergent.

Continue in this way. After k steps we have obtained a subsequence (m_j) from \mathbb{N} , such that

$$\left(\beta_i^{(m_j)}\right)_{j=1}^{+\infty} \quad \text{is convergent for all } i = 1, 2, \dots, k.$$

This means that (y_{m_j}) is a convergent subsequence of (y_m) , hence

$$y_{m_j} \rightarrow y \quad \text{for } j \rightarrow +\infty,$$

and

$$y = \sum_{i=1}^k \beta_i x_i.$$

We conclude from

$$\sum_{i=1}^k |\beta_i| \geq \sum_{i=1}^k \left| \beta_i^{(m_j)} \right| - \sum_{i=1}^k \left| \beta_i^{(m_j)} - \beta_i \right| = 1 - \sum_{i=1}^k \left| \beta_i^{(m_j)} - \beta_i \right| \rightarrow 1, \quad \text{for } j \rightarrow +\infty,$$

and from the assumption that x_1, \dots, x_k are linearly independent that $y \neq 0$. This is contradicting the assumption that $\|y_m\| \rightarrow 0$ for $m \rightarrow +\infty$.

We infer that if $\sum_{i=1}^k |\beta_i| = 1$, then there is a constant $c > 0$, such that

$$\left\| \sum_{i=1}^k \beta_i x_i \right\| \geq c.$$

We put for $(\alpha_1, \dots, \alpha_k) \neq (0, \dots, 0)$,

$$\beta_i = \frac{\alpha_i}{|\alpha_1| + \dots + |\alpha_k|}.$$

Then the claim follows when we multiply by $|\alpha_1| + \dots + |\alpha_k| \neq 0$.

Finally, we notice that the case $\alpha_1 = \dots = \alpha_k = 0$ follows trivially for quite other reasons.

Example 2.9 Let V be a vector space and let $\|\cdot\|$ and $\|\|\cdot\|\|$ be two norms on V . The norms are said to be equivalent if there are positive constants m and M such that

$$m\|x\| \leq \|\|x\|\| \leq M\|x\|$$

for all $x \in V$.

Show that all norms on a finite dimensional vector space are equivalent.

Show that all equivalent norms define the same closed sets.

Let e_1, \dots, e_k be a basis for V . It follows from EXAMPLE 2.8 that there are constants $c_1 > 0$ and $c_2 > 0$, such that

$$\left\| \sum_{i=1}^k \alpha_i e_i \right\| \geq c_1 \sum_{i=1}^k |\alpha_i| \quad \text{and} \quad \|\| \sum_{i=1}^k \alpha_i e_i \|\| \geq c_2 \sum_{i=1}^k |\alpha_i|.$$

Writing $x = \sum_{i=1}^k \alpha_i e_i$, we get

$$\begin{aligned} \|x\| &= \left\| \sum_{i=1}^k \alpha_i e_i \right\| \leq \sum_{i=1}^k |\alpha_i| \cdot \|e_i\| \leq \max_{1 \leq i \leq k} \|e_i\| \cdot \sum_{j=1}^k |\alpha_j| \leq \frac{1}{c_2} \max_{1 \leq i \leq k} \|e_i\| \cdot \|\| \sum_{j=1}^k \alpha_j e_j \|\| \\ &= \frac{1}{c_2} \max_{1 \leq i \leq k} \|e_i\| \cdot \|x\| \leq \frac{1}{c_2} \max_{1 \leq i \leq k} \|e_i\| \cdot \sum_{j=1}^k |\alpha_j| \cdot \|e_j\| \\ &\leq \frac{1}{c_2} \max_{1 \leq i \leq k} \|e_i\| \cdot \max_{1 \leq j \leq k} \|e_j\| \cdot \sum_{\ell=1}^k |\alpha_\ell| \leq \frac{1}{c_1} \cdot \frac{1}{c_2} \max_{1 \leq i \leq k} \|e_i\| \cdot \max_{1 \leq j \leq k} \|e_j\| \cdot \|x\|. \end{aligned}$$

Please click the advert







www.1calendar.dk

Thus we have proved that

$$\|x\| \leq a \cdot \|x\| \leq b \cdot \|x\|,$$

where

$$a = \frac{1}{c_2} \max_{1 \leq i \leq k} \|e_i\| > 0 \quad \text{and} \quad b = a \cdot \frac{1}{c_1} \max_{1 \leq j \leq k} \|e_j\| > 0.$$

When we divide by $a > 0$, we get

$$m\|x\| = \frac{1}{a} \|x\| \leq \|x\| \leq \frac{b}{a} \|x\| = M\|x\|,$$

and we have proved that any two norms on a finite dimensional subspace are equivalent.

Since

$$m\|x\| \leq \|x\| \leq M\|x\|, \quad 0 < m \leq M,$$

and

$$\frac{1}{M} \|x\| \leq \|x\| \leq \frac{1}{m} \|x\|,$$

are equivalent, it suffices to prove that if U is closed with respect to $\|\cdot\|$, then U is also closed with respect to $\|\cdot\|$.

It is well-known (cf. EXAMPLE 1.10) that U is closed, if and only if

$$x_n \in U \text{ and } x_n \rightarrow x \implies x \in U.$$

Assume that U is closed with respect to $\|\cdot\|$, and let $(x_n) \subseteq U$ be a sequence for which

$$\|x_n\| \rightarrow 0 \quad \text{for } n \rightarrow +\infty,$$

thus (x_n) is convergent with respect to the norm $\|\cdot\|$. We shall prove that $x \in U$. However,

$$\|x_n - x\| \leq \frac{1}{m} \|x_n - x\| \rightarrow 0 \quad \text{for } n \rightarrow +\infty,$$

so also $x_n \rightarrow x$ with respect to the norm $\|\cdot\|$. It follows from the condition of EXAMPLE 1.10 (applied with respect to $\|\cdot\|$) that $x \in U$, and the claim is proved.

Example 2.10 *Show that a compact set in a normed vector space V is closed and bounded. If V is finite dimensional, show that a closed and bounded set is compact.*

Assume that U is compact in V , i.e. every sequence $(x_n) \subseteq U$ has a subsequence (y_n) , which converges towards an element y in U . We shall prove that U is closed and bounded.

Assume that $(x_n) \subseteq U$ is convergent in V , thus $x_n \rightarrow x \in V$. It follows from EXAMPLE 1.10 that U is closed, if we can prove that also $x \in U$.

According to the assumption there is a subsequence (y_n) of (x_n) , such that $y_n \rightarrow y \in U$. However, since $x_n \rightarrow x$, also $y_n \rightarrow x$, and since the limit value is unique in normed spaces, we conclude that $x = y \in U$, and it follows that U is closed.

Then we shall prove that if U is compact, then U is bounded. *Indirect proof.* Assume that U is unbounded. Let $x_1 \in U$ be arbitrarily chosen. There exists an $x_2 \in U$, such that

$$\|x_2\| \geq 1 + \|x_1\|.$$

Choose inductively a sequence $(x_n) \subseteq U$, such that

$$\|x_{n+1}\| \geq 1 + \|x_n\|.$$

Then note that if x_n and x_{n+p} , $p \in \mathbb{N}$ are any two elements, then

$$\|x_{n+p}\| \geq 1 + \|x_{n+p-1}\| \geq 2 + \|x_{n+p-2}\| \geq \cdots \geq p + \|x_n\|,$$

hence

$$\|x_{n+p} - x_n\| \geq \|x_{n+p}\| - \|x_n\| \geq 0 \geq 1 \quad \text{for alle } p \in \mathbb{N},$$

proving that no subsequence of (x_n) is convergent, and U is not compact.

We get by contraposition that if U is compact, then U is bounded.

Assume now that V is finite dimensional and that U is bounded and closed. Let e_1, \dots, e_k denote a basis for V , and let the constant $c > 0$ be chosen as in EXAMPLE 2.8, such that

$$\left\| \sum_{i=1}^k \alpha_i e_i \right\| \geq c(|\alpha_1| + \cdots + |\alpha_k|) = c \sum_{i=1}^k |\alpha_i|.$$

Let $x_n \in U$, $x_n = \sum_{i=1}^k \alpha_i^n e_i$, be any sequence. It follows from U being bounded that $\|x\| \leq B$ for every $x \in U$, i.e.

$$|\alpha_i| \leq \sum_{i=1}^k |\alpha_i| \leq \frac{1}{c} \left\| \sum_{i=1}^k \alpha_i e_i \right\| \leq \frac{B}{c}$$

for all $i = 1, \dots, k$. Hence the sequence $(\alpha_1^n)_n$ is bounded, and it has therefore a convergent subsequence $(\alpha_1^{n_j^1})$.

Since $(\alpha_2^{n_j^1})$ is a bounded sequence, it has a convergent subsequence $(\alpha_2^{n_j^2})$, etc..

After k steps we have found a sequence (n_j) , for which $(\alpha_i^{n_j})_j$ is convergent for $j \rightarrow +\infty$ for every $i = 1, \dots, k$, of limit value α_i .

Putting

$$y_j = \sum_{i=1}^k \alpha_i^{n_j} e_i,$$

we get that (y_j) is convergent of limit

$$y_j \rightarrow y = \sum_{i=1}^k \alpha_i e_i.$$

Since $y_j \in U$, and U is closed, we get $y \in U$ according to EXAMPLE 1.10, and the claim is proved.

Example 2.11 *Riesz's lemma.* Let V be a normed vector space and let U be a closed subspace of V , $U \neq V$. Let α , $0 < \alpha < 1$, be given. Show that there is a $v \in V$, such that

$$\|v\| = 1 \quad \text{and} \quad \|v - u\| \geq \alpha \quad \text{for all } u \in U.$$

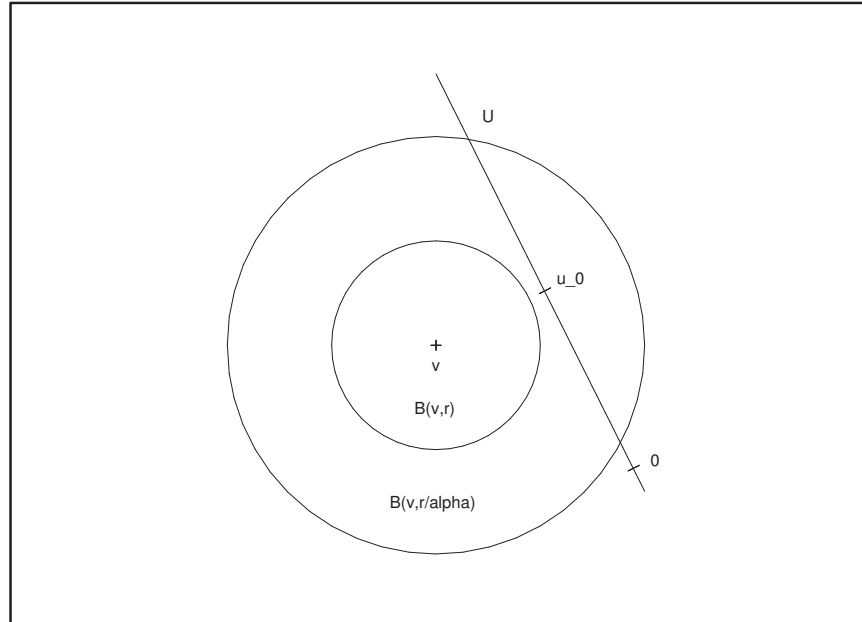

It follows from $U \neq V$, that there exists a $v \in V \setminus U$.

The set U is closed, so $V \setminus U$ is open. Hence there exists an $r > 0$, such that $B(v,r) \cap U = \emptyset$, where $B(v,r)$ denotes the open ball of centre v and radius r . This means that

$$(9) \quad \|v - u\| \geq r \quad \text{for all } u \in U.$$

Choose r sufficiently large such that (cf. the figure)

$$B(v,r) \cap U = \emptyset \quad \text{and} \quad B\left(v, \frac{1}{\alpha} r\right) \cap U \neq \emptyset.$$

Then for every $u_0 \in B\left(v, \frac{1}{\alpha} r\right) \cap U$,

$$(10) \quad r \leq \|v - u_0\| \leq \frac{1}{\alpha} r.$$

If we put

$$w = \frac{v - u_0}{\|v - u_0\|},$$

then $\|w\| = 1$.

We have for any $u \in U$ that

$$\|w - u\| = \left\| \frac{v - u_0}{\|v - u_0\|} - u \right\| = \frac{1}{\|v - u_0\|} \|v - u_0 - \|v - u_0\| u\|.$$

Now $u, u_0 \in U$, and U is a subspace, hence $u_0 + \|v - u_0\| u \in U$. By applying (9) with $u_0 + \|v - u_0\| u$ instead of u , it follows from (10) that

$$\|w - u\| = \frac{1}{\|v - u_0\|} \|v - (u_0 + \|v - u_0\| u)\| \geq \frac{r}{\|v - u_0\|} \geq \frac{r}{\frac{1}{\alpha} r} = \alpha.$$

We have proved that $w \in V$ satisfies

$$\|w\| = 1 \quad \text{and} \quad \|w - u\| \geq \alpha \quad \text{for every } u \in U.$$

Please click the advert

**Design your
own future at
MAN Diesel**

www.mandiesel.com

MAN Diesel – Powering the World



Download free books at BookBooN.com

Example 2.12 In ℓ^∞ , the vector space of bounded sequences, we consider the sets U_1 and U_2 , where U_1 denotes the set of sequences with only finitely many elements different from 0 and U_2 the set of sequences with all but the N first elements equal to 0.

Are U_1 and/or U_2 closed subspaces in ℓ^∞ ?

Are U_1 and/or U_2 finite dimensional?

It follows from

$$x_n = \left(1, \frac{1}{2}, \frac{1}{3}, \dots, \frac{1}{n}, 0, 0, \dots\right) \in U_1,$$

and

$$x_n \rightarrow \left(\frac{1}{k}\right)_{k \in \mathbb{N}} \notin U_1,$$

that U_1 is not closed.

Of course U_1 is a subspace, and since every *finite dimensional* subspace is closed (which U_1 is not), we conclude that U_1 is not finite dimensional.

On the other hand, U_2 and \mathbb{R}^N are isomorphic, so U_2 is a closed and finite dimensional vector space, $\dim U_2 = N$.

Example 2.13 Let $(V, \|\cdot\|)$ be a normed vector space, and let U be the unit ball,

$$U = \{x \in V \mid \|x\| \leq 1\}.$$

Prove that U is compact, if and only if V is finite dimensional.

Obviously, U is closed and bounded. If V is finite dimensional, then it follows from EXAMPLE 2.10 that U is compact. It remains to be proved that if U is compact, then V is finite dimensional.

INDIRECT PROOF. Assume that V is not finite dimensional. Choose any $x_1 \in U$, such that $\|x_1\| = 1$. Then x_1 generates a subspace V_1 . Then by Riesz's lemma (EXAMPLE 2.11) there exists an $x_2 \in U$, such that

$$\|x_2\| = 1 \quad \text{and} \quad \|x_2 - \lambda x_1\| \geq \frac{1}{2} \quad \text{for all } \lambda.$$

By induction, using Riesz's lemma in each step, we obtain a sequence $x_n \in U$ of unit vectors, $\|x_n\| = 1$, such that

$$\left\|x_n - \sum_{j=1}^{n-1} \lambda_j x_j\right\| \geq \frac{1}{2} \quad \text{for any } \lambda_j.$$

We have in particular,

$$\|x_n - x_m\| \geq \frac{1}{2} \quad \text{for } n \neq m,$$

proving that (x_n) does not contain any convergent subsequence. Hence U is not compact.

We get by contraposition that if the unit ball U is compact, then the vector space V is finite dimensional.

Example 2.14 Consider in ℓ^p (where $1 \leq p \leq +\infty$) the subspace U consisting of all sequences which are 0 eventually.

- 1) If $1 \leq p < +\infty$, is the subspace U then dense in ℓ^p ?
- 2) If $p = +\infty$, is the subspace U then dense in ℓ^∞ ?

1) The answer is 'yes'. In fact, if $(x_j)_{j \in \mathbb{N}} \in \ell^p$, then

$$\sum_{j=1}^{+\infty} |x_j|^p < +\infty.$$

To every $\varepsilon > 0$ there is an N , such that

$$\sum_{j=N+1}^{+\infty} |x_j|^p < \varepsilon^p.$$

Putting $x^N = (x_1, \dots, x_N, 0, 0, \dots) \in U$, we get

$$\|x - x^N\|_p = \left\{ \sum_{j=N+1}^{+\infty} |x_j|^p \right\}^{\frac{1}{p}} < \{\varepsilon^p\}^{\frac{1}{p}} = \varepsilon.$$

2) In this case the answer is 'no'. In fact, if $x = (1, 1, 1, \dots) \in \ell^\infty$, then

$$\|x - y\|_\infty \geq 1 \quad \text{for every } y \in U.$$

Please click the advert

The advertisement features a light blue background with four icons arranged in a row, separated by plus signs. From left to right: a shopping cart icon labeled 'Student Discounts', a calendar icon labeled 'Student Events', a pound sterling symbol (£) labeled 'Money Saving Advice', and a yellow envelope with three stars labeled 'Happy Days!'. An equals sign follows the last icon.

wealthystudent.co.uk

Example 2.15 On $C([a, b])$ we introduce the norm

$$\|f\|_p = \left\{ \int_a^b |f(t)|^p dt \right\}^{\frac{1}{p}}, \quad p \in]1, +\infty[.$$

Let $g \in C([a, b])$, and let q be given by $\frac{1}{p} + \frac{1}{q} = 1$. Prove that we by

$$T_g f = \int_a^b f(t) \overline{g(t)} dt$$

define a linear functional on $C([a, b])$, and that

$$\|T_g\| = \|g\|_q \quad \left(= \left\{ \int_a^b |g(t)|^q dt \right\}^{\frac{1}{q}} \right).$$

Most of the claims have already been proved, included the estimate $\|T_g\| \leq \|g\|_1$. We shall only proof that we even get equality. The trick is to choose a suitable $f \in C([a, b])$. We have

$$T_g f = \int_a^b f(t) \overline{g(t)} dt.$$

Since $g(t)$ is continuous, we get

$$g(t) = e^{i\varphi(t)} |g(t)|,$$

where $\varphi(t)$ can be chosen continuous in every interval, in which $g(t) \neq 0$.

Choosing

$$f(t) = e^{i\varphi(t)} |g(t)|^{\frac{q}{p}},$$

f is again continuous and

$$\|f\|_p^p = \int_a^b |g(t)|^q dt = \|g\|_q^q, \quad \text{thus} \quad \|f\|_p = \|g\|_q^{\frac{q}{p}} = \|g\|_q^{q-1},$$

and

$$\begin{aligned} T_g f &= \int_a^b f(t) \overline{g(t)} dt = \int_a^b e^{i\varphi(t)} |g(t)|^{\frac{q}{p}} e^{-i\varphi(t)} |g(t)| dt \\ &= \int_a^b |g(t)|^{\frac{q}{p}+1} dt = \int_a^b |g(t)|^{q(\frac{1}{p}+\frac{1}{q})} dt = \int_a^b |g(t)|^q dt \\ &= \|g\|_q^q = \|g\|_q \cdot \|g\|_q^{q-1} = \|g\|_q \cdot \|f\|_p. \end{aligned}$$

It follows from

$$|T_g f| = T_g f = \|g\|_q \|f\|_p \leq \|T_g\| \cdot \|f\|_p,$$

that $\|g\|_q \leq \|T_g\|$. Since already $\|T_g\| \leq \|g\|_q$, we must have $\|T_g\| = \|g\|_q$.

2.3 Banach spaces

Example 2.16 Show that a closed subspace of a Banach space is itself a Banach space.

Let U be a closed subspace of a Banach space V . Since V is complete, it follows from EXAMPLE 1.10 that U is also complete, hence U is a Banach space.

Example 2.17 Let $V_i, i = 1, 2, \dots, n$, be normed vector spaces, with norms $\|\cdot\|_i, i = 1, 2, \dots, n$. The product space $V_1 \times V_2 \times \dots \times V_n = \bigotimes_{i=1}^n V_i$ is defined by

$$\bigotimes_{i=1}^n V_i = \{(x_1, x_2, \dots, x_n) \mid x_i \in V_i, i = 1, 2, \dots, n\}.$$

In $\bigotimes_{i=1}^n V_i$ we use coordinate wise addition:

$$(x_1, x_2, \dots, x_n) + (y_1, y_2, \dots, y_n) = (x_1 + y_1, x_2 + y_2, \dots, x_n + y_n),$$

and scalar multiplication:

$$\lambda(x_1, x_2, \dots, x_n) = (\lambda x_1, \lambda x_2, \dots, \lambda x_n),$$

and we define the norm by

$$\|(x_1, x_2, \dots, x_n)\| = \sum_{i=1}^n \|x_i\|_i.$$

Show that $\bigotimes_{i=1}^n V_i$ with this norm is a normed vector space, and show that if all the spaces V_i with their respective norms are Banach spaces, then $\bigotimes_{i=1}^n V_i$ is a Banach space.

We shall prove the claim by induction over n . For $n = 1$ there is nothing to prove.

If $n = 2$, then clearly $V_1 \times V_2$ is a vector space with the operations addition and scalar multiplication defined above. Then we shall prove that

$$\|(x_1, x_2)\| = \|x_1\|_1 + \|x_2\|_2$$

is a norm.

Clearly, $\|(x_1, x_2)\| \geq 0$, and if $\|(x_1, x_2)\| = \|x_1\|_1 + \|x_2\|_2 = 0$, then both $\|x_1\|_1 = 0$ and $\|x_2\|_2 = 0$, thus $x_1 = 0$ og $x_2 = 0$.

Furthermore,

$$\|\lambda(x_1, x_2)\| = \|(\lambda x_1, \lambda x_2)\| = \|\lambda x_1\|_1 + \|\lambda x_2\|_2 = |\lambda| (\|x_1\|_1 + \|x_2\|_2) = |\lambda| \cdot \|(x_1, x_2)\|.$$

Finally,

$$\begin{aligned} \|(x_1, x_2) + (y_1, y_2)\| &= \|(x_1 + y_1, x_2 + y_2)\| = \|x_1 + y_1\|_1 + \|x_2 + y_2\|_2 \\ &\leq \|x_1\|_1 + \|y_1\|_1 + \|x_2\|_2 + \|y_2\|_2 \\ &= (\|x_1\|_1 + \|x_2\|_2) + (\|y_1\|_1 + \|y_2\|_2) \\ &= \|(x_1, x_2)\| + \|(y_1, y_2)\|, \end{aligned}$$

and we have proved that $\|\cdot\|$ is a norm on $V_1 \times V_2$.

Then assume that both V_1 and V_2 are complete, and let $((x_1^n, x_2^n))_n$ be a Cauchy sequence on $V_1 \times V_2$. It follows from

$$\|x_i^n - x_i^m\|_i \leq \|(x_1^n - x_1^m, x_2^n - x_2^m)\| = \|(x_1^n, x_2^n) - (x_1^m, x_2^m)\|, \quad t = 1, 2,$$

that $(x_i^n)_n$ are Cauchy sequences on V_i , $i = 1, 2$, hence convergent with limit values x_i , $i = 1, 2$. By this construction we then get

$$\|(x_1, x_2) - (x_1^n, x_2^n)\| = \|x_1 - x_1^n\|_1 + \|x_2 - x_2^n\|_2 \rightarrow 0 \quad \text{for } n \rightarrow +\infty,$$

proving that $(x_1^n, x_2^n) \rightarrow (x_1, x_2) \in V_1 \times V_2$. We have proved that $V_1 \times V_2$ is complete, thus $(V_1 \times V_2, \|\cdot\|)$ is a Banach space.

Assume that the claims are true for some $n \in \mathbb{N}$ (this is true by the above for $n = 1$ and for $n = 2$), and consider $\bigotimes_{i=1}^{n+1} U_i$, where each U_i is a normed vector space (a Banach space). We define

$$V_1 = \bigotimes_{i=1}^n U_i \quad \text{and} \quad V_2 = U_{n+1}.$$

It follows from the assumption of the induction that $(V_1, \|\cdot\|_n^*)$ is a normed vector space (or a Banach space) under the given assumptions, and the same is true for the space $(V_2, \|\cdot\|_{n+1})$. It only remains to notice that

$$\|(x_1, x_2, \dots, x_n)\|_n^* = \|x_1\|_1 + \|x_2\|_2 + \dots + \|x_n\|_n,$$

hence

$$\|(x_1, \dots, x_n, x_{n+1})\| = \|(x_1, \dots, x_n)\|_n^* + \|x_{n+1}\|_{n+1}.$$

It follows that $\bigoplus_{i=1}^{n+1} U_i$ is a normed vector space (or a Banach space) under the given assumptions.

Example 2.18 Assume that V and U are normed spaces and $f : V \rightarrow U$ is a continuous mapping, and assume that $X \subset V$ is a compact subset. Show that the image $f(X) \subset U$ is compact. Show that a real function attains both maximum and minimum on a compact set.

There are several definitions of compactness. We shall here use *sequential compactness*, which is defined by X being sequential compact, if every sequence on X has a convergent subsequence.

We shall prove that if $f : V \rightarrow U$ is continuous, and $X \subset V$ is compact, then the image $f(X) \subset U$ is also compact.

Let $(y_n) \subset f(X)$ be any sequence on the image $f(X)$. There exists a sequence $(x_n) \subset X$, such that $y_n = f(x_n)$ for every $n \in \mathbb{N}$. Since X is compact, (x_n) has a convergent subsequence $(x'_n) \subseteq (x_n)$, where $x'_n \rightarrow x_0 \in X$ for $n \rightarrow +\infty$.

Now, f is continuous at $x_0 \in X$, so to every $\varepsilon > 0$ there exists a $\delta > 0$, such that

$$\|f(x'_n) - f(x_0)\|_U < \varepsilon \quad \text{for } \|x'_n - x_0\|_V < \delta.$$

Then $(x'_n) \rightarrow x_0$ implies that there exists an $n_0 \in \mathbb{N}$, such that

$$\|x'_n - x_0\|_V < \delta \quad \text{for all } n \geq n_0.$$

We have for the same n_0 that

$$\|f(x'_n) - f(x_0)\|_U < \varepsilon \quad \text{for all } n \geq n_0,$$

which means that $(f(x'_n))$ converges towards $f(x_0)$, thus every sequence $(y_n) = (f(x_n)) \subseteq f(X)$ has a convergent subsequence $(y'_n) = (f(x'_n))$. Note for the limit point that $f(x_0) \in f(X)$.

Assume that $f : X \rightarrow \mathbb{R}$ is continuous, where X is a compact subset of a normed space. It follows from the above that $f(X) \subseteq \mathbb{R}$ is compact, thus closed and bounded in \mathbb{R} . In particular, f has both a maximum value and a minimum value.

Please click the advert

WHAT'S MISSING IN THIS EQUATION?

You could be one of our future talents

MAERSK INTERNATIONAL TECHNOLOGY & SCIENCE PROGRAMME

Are you about to graduate as an **engineer** or **geoscientist**? Or have you already graduated?
If so, there may be an exciting future for you with A.P. Moller - Maersk.



MAERSK

www.maersk.com/mitas

Example 2.19 Show that any finite dimensional subspace of a normed vector space is a Banach space.

Let $(V, \|\cdot\|)$ be the normed space, and let U be a finite dimensional subspace of V . Let e_1, \dots, e_k , denote a basis for U . It follows from EXAMPLE 2.8 that there exists a constant $c > 0$ (corresponding to the basis e_1, \dots, e_k), such that

$$\left\| \sum_{i=1}^k \alpha_i e_i \right\| \geq c(|\alpha_1| + \dots + |\alpha_k|).$$

Let $x^n = \sum_{i=1}^k \alpha_i^n e_i$ denote a Cauchy sequence on U , thus

$$\forall \varepsilon > 0 \exists N \forall m, n \geq N : \|x^m - x^n\| = \left\| \sum_{i=1}^k (\alpha_i^m - \alpha_i^n) e_i \right\| < \varepsilon.$$

Then in particular,

$$|\alpha_i^m - \alpha_i^n| \leq \sum_{i=1}^k |\alpha_i^m - \alpha_i^n| \leq \frac{1}{c} \left\| \sum_{i=1}^k (\alpha_i^m - \alpha_i^n) e_i \right\| < \frac{\varepsilon}{c} \quad \text{for } m, n \geq N.$$

It follows that $(\alpha_i^n)_n$ is a Cauchy sequence on \mathbb{C} for every $i = 1, \dots, k$, hence convergent, $\alpha_i^n \rightarrow \alpha_i$ for $n \rightarrow +\infty$.

In this way we construct an element

$$x = \sum_{i=1}^k \alpha_i e_i \in U.$$

It remains to be proved that $x^n \rightarrow x$ for $n \rightarrow +\infty$. However,

$$\|x - x^n\| = \left\| \sum_{i=1}^k (\alpha_i - \alpha_i^n) e_i \right\| \leq \sum_{i=1}^k |\alpha_i - \alpha_i^n| \cdot \|e_i\| \rightarrow 0 \quad \text{for } n \rightarrow +\infty,$$

because every term in the finite sum tends towards 0 for $n \rightarrow +\infty$. This proves that every finite dimensional subspace of a normed vector space is a Banach space.

Example 2.20 Let V be a Banach space. A series $\sum_{k=0}^{\infty} x_k$, $x_k \in V$, is convergent if the sequence (s_n) , where

$$s_n = \sum_{k=0}^n x_k,$$

is convergent in V .

Show that $\sum_{k=0}^{\infty} \|x_k\| < \infty$ implies that $\sum_{k=0}^{\infty} x_k$ is convergent.

Does the convergence of $\sum_{k=0}^{\infty} x_k$ imply that $\sum_{k=0}^{\infty} \|x_k\| < \infty$?

What if the space V is only assumed to be a normed space?

1) Given a Banach space V . It suffices to prove that (s_n) is a Cauchy sequence.

Let $\varepsilon > 0$ be given. Since

$$\sum_{k=0}^{\infty} \|x_k\| < +\infty,$$

is finite, there exists an N , such that

$$\sum_{k=N}^{\infty} \|x_k\| < \varepsilon.$$

It holds for $n > m \geq N$ that

$$\|s_n - s_m\| = \left\| \sum_{k=0}^n x_k - \sum_{k=0}^m x_k \right\| = \left\| \sum_{k=m+1}^n x_k \right\| \leq \sum_{k=m+1}^n \|x_k\| \leq \sum_{k=N}^{\infty} \|x_k\| < \varepsilon,$$

thus (s_n) is a Cauchy sequence in a Banach space, hence also convergent.

2) It is well-known that the claim does not hold in the simplest possible Banach space $(\mathbb{R}, |\cdot|)$, because there exist conditional convergent series like e.g.

$$\sum_{n=1}^{\infty} \frac{(-1)^{n+1}}{n} = \ln 2,$$

which are not absolutely convergent,

$$\sum_{n=1}^{\infty} \frac{1}{n} = \infty.$$

3) This is not true, either. Denote by c the vector space consisting of real sequences (x_n) , where $x_n = 0$ eventually, e.g. for $n \geq N(x)$. Choose as norm,

$$\|x\| = \sqrt{\sum_{n=1}^{\infty} x_n^2}.$$

Then c is dense in ℓ^2 , and $c \neq \ell^2$.

Choose $x_n = \frac{1}{n} e_n$. Then

$$\left\| \sum_{n=1}^{\infty} x_n \right\|^2 = \sum_{n=1}^{\infty} \|x_n\|^2 = \sum_{n=1}^{\infty} \frac{1}{n^2} = \frac{\pi^2}{6},$$

so $\sum_{n=1}^{\infty} x_n \in \ell^2$.

Clearly, $\sum_{n=1}^{\infty} x_n$ is not zero, eventually, while all $s_n = \sum_{k=1}^n x_k$ have this property. Hence

$$c \ni s_n \rightarrow \sum_{n=1}^{\infty} x_n \in \ell^2 \setminus c.$$

Example 2.21 Let $(V, \|\cdot\|)$ denote a normed space. Let V' denote the set of all bounded linear functionals on $(V, \|\cdot\|)$. The set V' is organized as a vector space by the operations

$$(f + g)(x) = f(x) + g(x), \quad \text{for all } x \in V,$$

$$(\alpha f)(x) = \alpha f(x), \quad \text{for all } x \in V,$$

and we introduce a norm on V' by

$$\|f\|' = \sum_{\|x\| \leq 1} |f(x)|.$$

Prove that $(V', \|\cdot\|')$ is a Banach space. It is called the dual space V .

We shall first show that $\|\cdot\|'$ is a norm on V' . It is obvious that $\|f\|' \geq 0$. If $\|f\|' = 0$, then

$$\sup_{\|x\| \leq 1} |f(x)| = 0.$$

Then we have $\left\| \frac{x}{\|x\|} \right\| = 1$ for arbitrary $x \neq 0$, hence

$$|f(x)| = \left| f \left(\|x\| \cdot \frac{x}{\|x\|} \right) \right| = \|x\| \cdot \left| f \left(\frac{x}{\|x\|} \right) \right| = 0.$$

It follows from $f(0) = 0$ that $f(x) = 0$ for every $x \in V$, thus $f \equiv 0$. Furthermore,

$$\|\alpha f\|' = \sup_{\|x\| \leq 1} |\alpha f(x)| = |\alpha| \cdot \sup_{\|x\| \leq 1} |f(x)| = |\alpha| \cdot \|f\|',$$

and finally,

$$\begin{aligned} \|f + g\|' &= \sup_{\|x\| \leq 1} |f(x) + g(x)| \leq \sup_{\|x\| \leq 1} (|f(x)| + |g(x)|) \\ &\leq \sup_{\|x\| \leq 1} |f(x)| + \sup_{\|x\| \leq 1} |g(x)| = \|f\|' + \|g\|', \end{aligned}$$

and we have proved that $\|\cdot\|'$ is a norm.

Assume that (f_n) is a Cauchy sequence on V' , i.e.

$$\forall \varepsilon > 0 \exists N \in \mathbb{N} \forall m, n \geq N : \|f_n - f_m\| < \varepsilon.$$

This means that

$$\|f_n - f_m\|' = \sup_{\|x\| \leq 1} |f_n(x) - f_m(x)| < \varepsilon \quad \text{for all } m, n \geq N,$$

i.e. we have for every x , for which $\|x\| \leq 1$ that $(f_n(x))$ is a Cauchy sequence in \mathbb{C} , hence convergent.

For any $x \neq 0$ it follows that $\frac{x}{\|x\|}$ is a unit vector, thus

$$\forall \varepsilon > 0 \exists N_x \in \mathbb{N} \forall m, n \geq N_x : \|f_n - f_m\|' < \frac{\varepsilon}{\|x\|},$$

which only means that

$$|f_n(x) - f_m(x)| = \|x\| \cdot \left| f_n\left(\frac{x}{\|x\|}\right) - f_m\left(\frac{x}{\|x\|}\right) \right| < \|x\| \cdot \frac{\varepsilon}{\|x\|} = \varepsilon,$$

so $(f_n(x))$ is convergent for every $x \in V \setminus \{0\}$. If $x = 0$, we just get $f_n(0) = 0 \rightarrow 0$ for $n \rightarrow +\infty$. If we put

$$f(x) = \lim_{n \rightarrow +\infty} f_n(x),$$

Please click the advert

CHALLENGE YOURSELF

WWW.STUDYINSWEDEN.SE

Today's job market values ambitious, innovative, perceptive team players. Swedish universities foster these qualities through a forward-thinking culture where you're close to the latest ideas and global trends.

Si.
Swedish Institute

Whatever your career goals may be, studying in Sweden will give you valuable skills and a competitive advantage for your future. www.studyinsweden.se

then we have defined a functional on V for which in particular $f(0) = 0$. It remains only to prove that 1) f is linear, and at 2) f is bounded. However,

$$f(x + \lambda y) = \lim_{n \rightarrow +\infty} f_n(x + \lambda y) = \lim_{n \rightarrow +\infty} \{f_n(x) + \lambda f_n(y)\} = f(x) + \lambda f(y),$$

proving the linearity. Then

$$\begin{aligned} (11) \|f\|' &= \sup_{\|x\| \leq 1} |f(x)| = \sup_{\|x\| \leq 1} |f(x) - f_n(x) + f_n(x)| \\ &\leq \sup_{\|x\| \leq 1} |f(x) - f_n(x)| + \sup_{\|x\| \leq 1} |f_n(x)| \\ &= \sup_{\|x\| \leq 1} |f(x) - f_n(x)| + \|f_n\|'. \end{aligned}$$

Choose n , such that for all $m \geq n$,

$$\|f_n - f_m\|' = \sup_{\|x\| \leq 1} |f_n(x) - f_m(x)| < 1.$$

Then $f_m(x) \in B(f_n(x), 1)$ for every x , for which $\|x\| \leq 1$. Since $f_m(x) \rightarrow f(x)$ for $m \rightarrow +\infty$, we have $f(x) \in \overline{B(f_n(x), 1)}$, so $|f_n(x) - f(x)| \leq 1$ for all x , for which $\|x\| \leq 1$. From this we infer that

$$\sup_{\|x\| \leq 1} |f(x) - f_n(x)| \leq 1.$$

Therefore, if n is chosen as above, then it follows from (11) that $\|f\|' \leq 1 + \|f_n\|'$, hence f is bounded, and we have proved that every Cauchy sequence on V' is convergent, i.e. V' is a Banach space.

2.4 The Lebesgue integral

‘n

Example 2.22 Let $f \in L^1(\mathbb{R})$.

- 1) Can we conclude that $f(x) \rightarrow 0$ for $|x| \rightarrow \infty$?
- 2) Can we find $a, b \in \mathbb{R}$ such that $|f(x)| \leq b$ for $|x| \geq a$?

In both cases the answer is ‘no’. For example, $g(x) = x \cdot 1_{\mathbb{Z}}(x)$ fulfils none of the conditions, and

$$\int |g(x)| dx = 0.$$

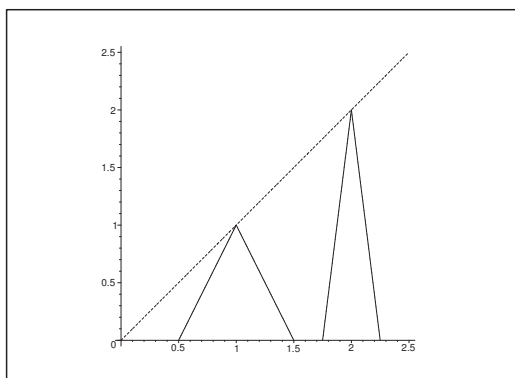

Figure 4: The graph of a *continuous function* $f(x)$, which does not fulfil the two requirements.

We shall now construct a function f , which is *continuous* and Lebesgue integrable, and which does not fulfil any of the two requirements above. Let

$$f(x) = \begin{cases} n & \text{for } x = n, & n \in \mathbb{N}, \\ 0 & \text{for } x = n \pm 2^{-n}, & n \in \mathbb{N}, \\ \text{piecewise linear,} & \text{otherwise.} \end{cases}$$

Clearly, f is continuous and satisfies neither (1) nor (2). We shall only prove that f is integrable. Now, $f \geq 0$, so

$$\int_{-\infty}^{+\infty} f(x) dx = \sum_{n=1}^{+\infty} \frac{1}{2} n \cdot 2 \cdot 2^{-n} = \sum_{n=1}^{+\infty} n 2^{-n} < +\infty,$$

and the claim is proved.

Remark 2.1 For completeness we here add the full proof. We have

$$\begin{aligned} \sum_{n=1}^{+\infty} n \cdot 2^{-n} &= 2 \sum_{n=1}^{+\infty} n \cdot 2^{-(n+1)} = 2 \sum_{n=2}^{+\infty} (n-1)2^{-n} = 2 \sum_{n=2}^{+\infty} n \cdot 2^{-n} - 2 \sum_{n=2}^{+\infty} 2^{-n} \\ &= 2 \sum_{n=1}^{+\infty} n \cdot 2^{-n} - 2 \cdot 1 \cdot 2^{-1} - \sum_{n=1}^{+\infty} 2^{-n} = 2 \sum_{n=1}^{+\infty} n \cdot 2^{-n} - 1 - 1, \end{aligned}$$

hence by a rearrangement,

$$\sum_{n=1}^{+\infty} n \cdot 2^{-n} = 2.$$

ALTERNATIVELY one may exploit that

$$\frac{d}{dz} \left(\frac{1}{1-z} \right) = \frac{1}{(1-z)^2} = \frac{d}{dz} \left(\sum_{n=0}^{+\infty} z^n \right) = \sum_{n=1}^{+\infty} n z^{n-1},$$

for $|z| < 1$. When we insert $z = \frac{1}{2}$, we easily get the result. \diamond

Example 2.23 *Prove that if $f : \mathbb{R} \rightarrow \mathbb{R}$ is monotonous, then f has at most countably many points of discontinuity.*

We may assume that f is increasing, thus $f(x) \geq f(y)$ for $x > y$. We may even restrict ourselves to the interval $[0, 1]$, because the number of intervals of the form $[n, n+1]$, $n \in \mathbb{Z}$, is countable. This means that we may assume that $f(x) = 0$ for $x \leq 0$, and $f(x) = 1$ for $x \geq 1$.

Let $\{x_j \mid j \in J\}$ be the set of all points of discontinuity in $[0, 1]$. Then to any x_j we can find an interval I_j with interior points on the Y -axis, such that $f(x) \notin I_j$ for all $x \in [0, 1]$, i.e. one jumps over the values in I_j over.

Every I_j can be “numbered” by a rational number $q_j \in I_j$, because \mathbb{Q} is dense in \mathbb{R} . This means that $\{x_j \mid j \in J\}$ contains just as many elements, as there are different elements in

$$\{q_j \mid j \in J\} \subseteq \mathbb{Q}.$$

Now, \mathbb{Q} is countable, so $\{q_j \mid j \in J\}$ is countable, and thus $\{x_j \mid j \in J\}$ is at most countable.

Define

$$f(x) = 2^{-n+1} \quad \text{for } x \in \left] \frac{1}{n+1}, \frac{1}{n} \right], \quad n \in \mathbb{N}.$$

Then f is monotonous of the countably many points of discontinuity $\left\{ \frac{1}{n} \mid n \in \mathbb{N} \setminus \{1\} \right\}$, showing that there exist monotonous functions with a countable number of points of discontinuity.

An ALTERNATIVE proof is the following: We may as before assume that f is increasing on the interval $[0, 1]$ with $f(x) = 0$ for $x \leq 0$ and $f(x) = 1$ for $x \geq 1$.

If x_0 is a point of discontinuity, then $f(x) \leq f(x_0)$ for every $x \leq x_0$. Hence, if $x_n \nearrow x_0$, then $(f(x_n))$ is an increasing bounded sequence of numbers, so $(f(x_n))$ is convergent with the limit value c .

Let $y_n \nearrow x_0$ be another such sequence of numbers. Then $(f(y_n)) \rightarrow c'$. We shall prove that $c = c'$. This is done INDIRECTLY.

Assume (e.g.) that $c < c'$, and let $0 < \varepsilon < c' - c$. Corresponding to this ε there exists an N , such that

$$|c' - f(y_n)| = c' - f(y_n) < \varepsilon \quad \text{for all } n \geq N.$$

To any y_n we can find an x_m , such that $y_n < x_m < x_0$, hence

$$f(y_n) \leq f(x_m) \quad [\leq c].$$

Then it follows that

$$\varepsilon < |c' - c| = c' - c = c' - f(y_n) + f(y_n) - c < \varepsilon + f(y_n) - c,$$

so $f(y_n) - c > 0$, and we have come to the contradiction

$$c < f(y_n) \leq f(x_m) \leq c \quad \text{for } n \geq N.$$

We therefore conclude that $c' = c$.

Since the limit value is the same, no matter how $x_n \nearrow x_0$ is chosen, we conclude that

$$c = \lim_{x \rightarrow x_0^-} f(x).$$

We prove in a similar way that $\lim_{x \rightarrow x_0^+} f(x)$ exists, and that these two values are different at any point of discontinuity.

Define the jump at a point of discontinuity x_0 as

$$\sigma_0 = \lim_{x \rightarrow x_0^+} f(x) - \lim_{x \rightarrow x_0^-} f(x) > 0.$$

If $x_0 < x_1$ are both points of discontinuity, then it follows from that the function is monotonous that

$$\lim_{x \rightarrow x_0^+} f(x) \leq \lim_{x \rightarrow x_1^-} f(x).$$

Let $\{x_j \mid j \in J\}$ denote the set of point of discontinuity in $[0, 1]$. The image is contained in $[0, 1]$, hence

$$\sum_{x_j} \sigma_j \leq 1,$$

and the sum is finite. Every $\sigma_j > 0$, so the sum is at most countable, thus $J \subseteq \mathbb{N}$, and the claim is proved.

Example 2.24 Prove that $f(x) = \frac{|\sin x|}{x}$ is not Lebesgue integrable on $[\pi, +\infty[$, thus $f \notin L^1([\pi, +\infty[)$.

HINT: Consider

$$f_n(x) = \begin{cases} \frac{|\sin x|}{x}, & \pi \leq x \leq n\pi, \\ 0, & \text{otherwise,} \end{cases}$$

and exploit that $f_n(x) \nearrow f(x)$ and $\int_{\pi}^{\infty} f_n(x) dx \geq \frac{1}{3} \sum_{k=2}^n \frac{1}{k}$.

Let f_n be given as above. Then clearly,

$$0 \leq f_n(x) \nearrow f(x).$$

Furthermore,

$$\begin{aligned} \int_{\pi}^{\infty} f_n(x) dx &= \int_{\pi}^{n\pi} \frac{|\sin x|}{x} dx = \sum_{k=2}^n \int_{(k-1)\pi}^{k\pi} \frac{|\sin x|}{x} dx \\ &\geq \sum_{k=2}^n \int_{(k-1)\pi}^{k\pi} \frac{1}{k\pi} \cdot |\sin x| dx = \sum_{k=2}^n \frac{1}{k\pi} \left| \int_{(k-1)\pi}^{k\pi} \sin x dx \right| \\ &= \sum_{k=2}^n \frac{1}{k\pi} \left| \int_0^{\pi} \sin x dx \right| = \sum_{k=2}^n \frac{2}{k\pi} = \frac{2}{\pi} \sum_{k=2}^n \frac{1}{k} \rightarrow +\infty \quad \text{for } n \rightarrow +\infty, \end{aligned}$$

and we infer that f is not Lebesgue integrable, i.e. f does not belong to $L^1([\pi, \infty[)$.

Example 2.25 Give a simple proof of Hölder's inequality in the case of $p = q = 2$ for the spaces of sequences.

We shall more precisely prove (Bohnenblust-Bunjakovski)-Cauchy-Schwarz-(Sobčyk)'s inequality

$$\sum_{i=1}^{+\infty} |x_i \bar{y}_i| = \sum_{i=1}^{\infty} |x_i| \cdot |y_i| \leq \|x\|_2 \cdot \|y\|_2,$$

if $x, y \in \ell^2$.

Please click the advert

www.job.oticon.dk

Using that $x + \lambda y \in \ell^2$ for every $\lambda \in \mathbb{R}$, we get

$$\begin{aligned} 0 &\leq \|x + \lambda y\|_2^2 = \sum_{i=1}^{+\infty} (x_i + \lambda y_i) \cdot (\bar{x}_i + \lambda \bar{y}_i) \\ &= \sum_{i=1}^{+\infty} \{ |x_i|^2 + \lambda^2 |y_i|^2 + \lambda \bar{x}_i y_i + \lambda x_i \bar{y}_i \} \\ &= \lambda^2 \sum_{i=1}^{+\infty} |y_i|^2 + \lambda \left\{ \sum_{i=1}^{+\infty} \bar{x}_i y_i + \sum_{i=1}^{+\infty} x_i \bar{y}_i \right\} + \sum_{i=1}^{+\infty} |x_i|^2, \end{aligned}$$

which we write in the form

$$\lambda^2 \cdot \|y\|_2^2 + \lambda \left\{ \sum_{i=1}^{+\infty} \bar{x}_i y_i + \sum_{i=1}^{+\infty} x_i \bar{y}_i \right\} + \|x\|_2^2 \geq 0.$$

This must hold for every real $\lambda \in \mathbb{R}$, so we must have

$$\begin{aligned} 0 &\geq B^2 - 4AC = \left\{ \sum_{i=1}^{\infty} \bar{x}_i y_i + \sum_{i=1}^{+\infty} x_i \bar{y}_i \right\}^2 - 4 \|x\|_2^2 \|y\|_2^2 \\ &= 4 \left(\operatorname{Re} \left\{ \sum_{i=1}^{+\infty} \bar{x}_i y_i \right\} - \{ \|x\|_2 \|y\|_2 \}^2 \right), \end{aligned}$$

hence

$$\left| \operatorname{Re} \left\{ \sum_{i=1}^{\infty} \bar{x}_i y_i \right\} \right| \leq \|x\|_2 \|y\|_2.$$

When x_i and y_i are all real, the inequality follows immediately.

In general,

$$\begin{aligned} \sum_{i=1}^{+\infty} |x_i \bar{y}_i| &= \sum_{i=1}^{+\infty} |x_i| \cdot |\bar{y}_i| \leq \|x\|_2 \cdot \|y\|_2 \\ &= \left\{ \sum_{i=1}^{+\infty} |x_i|^2 \right\}^{\frac{1}{2}} \left\{ \sum_{i=1}^{\infty} |y_i|^2 \right\}^{\frac{1}{2}} = \|x\|_2 \|y\|_2, \end{aligned}$$

and the claim is proved.

Example 2.26 Let $w(t) \geq 0$ be a non-negative function on \mathbb{R} . We define a linear functional I_w by

$$I_w(f) = \int_{\mathbb{R}} f(t) w(t) dt,$$

for $f \in L^1(\mathbb{R})$.

Assume that $|f|^p w$ and $|g|^q w$ are in $L^1(\mathbb{R})$, where f and g are (measurable) functions and $1 < p, q < \infty$ with $\frac{1}{p} + \frac{1}{q} = 1$.

1. Show the generalized Hölder's inequality

$$|I_w(fg)| \leq \{I_w(|f|^p)\}^{\frac{1}{p}} \{I_w(|g|^q)\}^{\frac{1}{q}},$$

where the inequality for $w = 1$ can be taken to be valid.

Now recall the Gamma function,

$$\Gamma(x) = \int_0^{\infty} t^{x-1} e^{-t} dt, \quad x > 0,$$

with the property $\Gamma(x + 1) = x\Gamma(x)$ for $x > 0$.

2. Use the generalized Hölder's inequality with

$$w(t) = t^{n-1} e^{-t}, \quad 0 < t < \infty, \quad \text{and} \quad p = q = 1,$$

to show that

$$\Gamma\left(n + \frac{1}{2}\right) \leq \frac{n!}{\sqrt{n}}, \quad n \in \mathbb{N}.$$

3. Give a similar estimation of $\Gamma(n + 1)$ by taking

$$w(t) = t^{n-\frac{1}{2}} e^{-t}, \quad 0 < t < \infty, \quad \text{and} \quad p = q = 2,$$

and deduce that

$$\frac{n!}{\sqrt{n + \frac{1}{2}}} \leq \Gamma\left(n + \frac{1}{2}\right) \leq \frac{n!}{\sqrt{n}}, \quad n \in \mathbb{N}.$$

1) We get from $w(t) \geq 0$ that both $w^{1/p}$ and $w^{1/q}$ are defined and that $w^{1/p} \cdot w^{1/q} = w$, and $f \cdot w^{1/p} \in L^p(\mathbb{R})$ and $g \cdot w^{1/q} \in L^q(\mathbb{R})$. Applying the usual Hölder's inequality we get

$$\begin{aligned} |I_w(f \cdot g)| &= \left| \int_{-\infty}^{+\infty} f(t) g(t) w(t) dt \right| \leq \int_{-\infty}^{+\infty} |f(t) w^{\frac{1}{p}}(t)| \cdot |g(t) w^{\frac{1}{q}}(t)| dt \\ &\leq \left\{ \int_{-\infty}^{+\infty} |f(t)|^p w(t) dt \right\}^{\frac{1}{p}} \left\{ \int_{-\infty}^{+\infty} |g(t)|^q w(t) dt \right\}^{\frac{1}{q}} = \{I_w(|f|^p)\}^{\frac{1}{p}} \{I_w(|g|^q)\}^{\frac{1}{q}}, \end{aligned}$$

and we have proved the generalized Hölder's inequality.

2) Then apply this generalized inequality on $f(t) = \sqrt{t} \cdot 1_{\mathbb{R}_+}(t)$ and $g(t) = 1$, and $w(t) = t^{n-1} e^{-t} \cdot 1_{\mathbb{R}_+}(t)$, we get

$$\begin{aligned} \Gamma\left(n + \frac{1}{2}\right) &= \int_0^{+\infty} \sqrt{t} \cdot 1 \cdot t^{n-1} e^{-t} dt \leq \{I_w(t)\}^{\frac{1}{2}} \{I_w(1)\}^{\frac{1}{2}} \\ &= \left\{ \int_0^{+\infty} t \cdot t^{n-1} e^{-t} dt \right\}^{\frac{1}{2}} \left\{ \int_0^{+\infty} 1 \cdot t^{n-1} e^{-t} dt \right\}^{\frac{1}{2}} \\ &= \left\{ \int_0^{+\infty} t^n e^{-t} dt \right\}^{\frac{1}{2}} \left\{ \int_0^{+\infty} t^{n-1} e^{-t} dt \right\}^{\frac{1}{2}} \\ &= \{\Gamma(n+1)\}^{\frac{1}{2}} \{\Gamma(n)\}^{\frac{1}{2}} = \{n!(n-1)!\}^{\frac{1}{2}} = \left\{ \frac{(n!)^2}{n} \right\}^{\frac{1}{2}} = \frac{n!}{\sqrt{n}}. \end{aligned}$$

3) Finitely, let $f(t) = \sqrt{t} \cdot 1_{\mathbb{R}_+}(t)$ and $g(t) = 1$, and $w(t) = t^{n-\frac{1}{2}} e^{-t} \cdot 1_{\mathbb{R}_+}(t)$. Then we get with $p = q = 2$,

$$\begin{aligned} n! &= \Gamma(n+1) = \int_0^{+\infty} t^n e^{-t} dt = \int_0^{+\infty} \sqrt{t} \cdot 1 \cdot t^{n-\frac{1}{2}} e^{-t} dt \\ &\leq \left\{ \int_0^{+\infty} t^{t+\frac{1}{2}} e^{-t} dt \right\}^{\frac{1}{2}} \left\{ \int_0^{+\infty} t^{n-\frac{1}{2}} e^{-t} dt \right\}^{\frac{1}{2}} \\ &= \left\{ \Gamma\left(n + \frac{3}{2}\right) \Gamma\left(n + \frac{1}{2}\right) \right\}^{\frac{1}{2}} = \left\{ \left(n + \frac{1}{2}\right) \left[\Gamma\left(n + \frac{1}{2}\right)\right]^2 \right\}^{\frac{1}{2}} = \sqrt{n + \frac{1}{2}} \cdot \Gamma\left(n + \frac{1}{2}\right), \end{aligned}$$

and we have

$$\frac{n!}{\sqrt{n + \frac{1}{2}}} \leq \Gamma\left(n + \frac{1}{2}\right) \leq \frac{n!}{\sqrt{n}}.$$

Remark 2.2 Furthermore, if we use that $\Gamma\left(\frac{1}{2}\right) = \sqrt{\pi}$, it follows from the functional equation that

$$\begin{aligned} \Gamma\left(n + \frac{1}{2}\right) &= \left(n - \frac{1}{2}\right) \Gamma\left(n - \frac{1}{2}\right) = \dots = \left(n - \frac{1}{2}\right) \left(n - \frac{3}{2}\right) \dots \frac{3}{2} \cdot \frac{1}{2} \Gamma\left(\frac{1}{2}\right) \\ &= \frac{(2n-1)(2n-3) \dots 3 \cdot 1}{2 \cdot 2 \dots 2 \cdot 2} \sqrt{\pi} \\ &= \frac{\sqrt{\pi}}{2^n} \cdot \frac{2n}{2n} \cdot \frac{2n-1}{1} \cdot \frac{2n-2}{2(n-1)} \dots \frac{4}{2 \cdot 2} \cdot \frac{3}{1} \cdot \frac{2}{2 \cdot 1} \cdot \frac{1}{1} \\ &= \frac{\sqrt{\pi}}{2^n} \cdot \frac{(2n)!}{2^n \cdot n!} = \frac{\sqrt{\pi}}{4^n} \binom{2n}{n} n!, \end{aligned}$$

hence by insertion

$$\frac{n!}{\sqrt{n + \frac{1}{2}}} \leq \frac{\sqrt{\pi}}{4^n} \binom{2n}{n} n! \leq \frac{n!}{\sqrt{n}},$$

thus

$$\frac{4^n}{\sqrt{\pi \left(n + \frac{1}{2}\right)}} \leq \binom{2n}{n} \leq \frac{4^n}{\sqrt{\pi n}},$$

which is in agreement with Stirling's formula

$$n! \sim \sqrt{2\pi} \cdot n^{n+\frac{1}{2}} e^{-n},$$

because

$$\binom{2n}{n} = \frac{(2n)!}{(n!)^2} \sim \frac{\sqrt{2\pi} \cdot (2n)^{2n+\frac{1}{2}} e^{-2n}}{\left\{\sqrt{2\pi} \cdot n^{n+\frac{1}{2}} \cdot e^{-n}\right\}^2} = \frac{1}{\sqrt{2\pi}} \cdot \frac{(2n)^{2n+\frac{1}{2}}}{n^{2n+1}} = \frac{2^{2n}\sqrt{2}}{\sqrt{2\pi}n} = \frac{4^n}{\sqrt{\pi n}}. \quad \diamond$$

Please click the advert



CHALLENGE YOURSELF

WWW.STUDYINSWEDEN.SE

Today's job market values ambitious, innovative, perceptive team players. Swedish universities foster these qualities through a forward-thinking culture where you're close to the latest ideas and global trends.

Whatever your career goals may be, studying in Sweden will give you valuable skills and a competitive advantage for your future. www.studyinsweden.se

Si.
Swedish Institute

Example 2.27 *Let*

$$F = \{f \in C^2([0, 1]) \mid f(0) = f(1) = 0\} \subseteq L^2([0, 1]).$$

1) Show that $\|f'\|_2^2 \leq \|f\|_2 \cdot \|f''\|_2$ for $f \in F$.

2) Let $f \in F$. Show that $|f(x)| \leq \|f'\|_2 \sqrt{x}$ for $0 \leq x \leq 1$, and deduce that

$$\|f\|_2 \leq \frac{1}{\sqrt{2}} \|f'\|_2.$$

3) Show that for $f \in C^2([0, 1])$ with $f(0) = f(1) = 0$ we have

$$\|f'\|_2 \leq \frac{1}{\sqrt{2}} \|f''\|_2.$$

4) Show by a counterexample that the result from question (3) is not valid for general $f \in C^2([0, 1])$.

1) We deduce from $f \in C^2([0, 1])$ and $f(0) = f(1) = 0$ and a partial integration, followed by an application of the Cauchy-Schwarz inequality that

$$\begin{aligned} \|f'\|_2^2 &= \int_0^1 f'(t) \overline{f'(t)} dt = \left[f(t) \overline{f'(t)} \right]_0^1 - \int_0^1 f(t) \overline{f''(t)} dt \\ &\leq 0 + \int_0^1 |f(t)| \cdot |f''(t)| dt \leq \|f\|_2 \cdot \|f''\|_2. \end{aligned}$$

2) From

$$f(x) = f(0) + \int_0^x f'(t) dt = \int_0^1 1_{[0,x]}(t) f'(t) dt$$

follows by Cauchy-Schwarz's inequality that

$$|f(x)| = \left| \int_0^1 1_{[0,x]}(t) f'(t) dt \right| \leq \|1_{[0,x]}\|_2 \cdot \|f'\|_2 = \sqrt{x} \cdot \|f'\|_2,$$

where we have used that

$$\|1_{[0,x]}\|_2 = \sqrt{\int_0^1 1_{[0,x]}(t) dt} = \sqrt{\int_0^x 1 dt} = \sqrt{x}.$$

3) Let $f \in F$. It follows from (1) and (2) that

$$\begin{aligned} \|f'\|_2^2 &\leq \|f\|_2 \cdot \|f''\|_2 = \left\{ \int_0^1 |f(x)|^2 dx \right\}^{\frac{1}{2}} \cdot \|f''\|_2 \leq \left\{ \int_0^1 x \|f'\|_2^2 dx \right\}^{\frac{1}{2}} \|f''\|_2 \\ &= \left\{ \int_0^1 x dx \right\}^{\frac{1}{2}} \|f'\|_2 \cdot \|f''\|_2 = \frac{1}{\sqrt{2}} \|f'\|_2 \|f''\|_2. \end{aligned}$$

If $\|f'\|_2 = 0$, the inequality is obvious.

If $\|f'\|_2 > 0$, we obtain the inequality when we divide by $\|f'\|_2$.

We derived the above by assuming that $f \in F$, thus $f(0) = f(1) = 1$.

Now, let $f(0) = f(1) = c$. Then $f(x) - c \in F$, hence

$$\|f'\|_2 = \|(f - c)'\|_2 \leq \frac{1}{\sqrt{2}} \|(f - c)''\|_2 = \frac{1}{\sqrt{2}} \|f''\|_2.$$

4) Finally, let $f(x) = ax$. Then $f'(x) = a$ and $f''(x) = 0$, hence

$$\|f'\|_2 = |a| \quad \text{og} \quad \|f''\|_2 = 0,$$

and the inequality is not fulfilled for any $a \neq 0$.

Example 2.28 1) Let $1 \leq p \leq q \leq \infty$. Show that $\ell^p \subset \ell^q$.

2) Let $1 \leq r < p < 2r$ and assume that the sequence (x_n) satisfies

$$\sum_{n=1}^{\infty} n |x_n|^p < \infty.$$

Show that $(x_n) \in \ell^r$.

1) If $(x_n) \in \ell^p$, then $\sum_{n=1}^{+\infty} |x_n|^p < +\infty$. In particular, $x_n \rightarrow 0$ for $n \rightarrow +\infty$, hence there exists an $N \in \mathbb{N}$, such that $|x_n| < 1$ for all $n \geq N + 1$.

For $p = q$ there is nothing to prove. If $1 \leq p < q < +\infty$, then

$$\sum_{n=1}^{+\infty} |x_n|^q = \sum_{n=1}^N |x_n|^q + \sum_{n=N+1}^{+\infty} |x_n|^p \cdot |x_n|^{q-p} < \sum_{n=1}^N |x_n|^q + \sum_{n=N+1}^{+\infty} |x_n|^p < +\infty,$$

showing that $(x_n) \in \ell^q$.

If $1 \leq p < q = +\infty$, then clearly

$$\sup_{n \in \mathbb{N}} |x_n| \leq \max \{1, \sup\{|x_n| \mid n = 1, \dots, N\}\} < +\infty,$$

and we conclude that $(x_n) \in \ell^\infty$.

2) Then let $1 \leq r < p < 2r$ and assume that

$$\sum_{n=1}^{+\infty} n |x_n|^p < +\infty.$$

Let $0 < s < 1$. We shall somehow way apply Hölder's inequality with $\tilde{p} = \frac{1}{s} > 1$ and $\tilde{q} = \frac{1}{1-s} > 1$. The assumption shall also be applied later on, so we get by a reasonable rewriting and an application of Hölder's inequality,

$$\sum_{n=1}^{+\infty} |x_n|^r = \sum_{n=1}^{+\infty} \{n |x_n|^p\}^s \left\{ \frac{1}{n^s} |x_n|^{r-sp} \right\} \leq \left\{ \sum_{n=1}^{+\infty} n |x_n|^p \right\}^s \cdot \left\{ \sum_{n=1}^{+\infty} n^{-\frac{s}{1-s}} |x_n|^{\frac{r-sp}{1-s}} \right\}^{1-s}.$$

By the assumption, the former factor is finite for every $s \in]0, 1[$. The task is to choose s in this interval, such that the latter factor also becomes finite.

Using that $2r > p$, we get $\frac{r-sp}{1-s} = 0$ for $s = \frac{r}{p} > \frac{1}{2}$. We get with this s that $\alpha = \frac{s}{1-s} > 1$ and

$$\sum_{n=1}^{+\infty} n^{-\frac{s}{1-s}} |x_n|^{\frac{r-sp}{1-s}} = \sum_{n=1}^{+\infty} \frac{1}{n^\alpha} \cdot |x_n|^0 = \sum_{n=1}^{+\infty} \frac{1}{n^\alpha} < +\infty,$$

and the latter factor in the estimate above is finite for this particular $s = \frac{r}{p} \in \left] \frac{1}{2}, 1 \right[$. Now, s does not occur in the sum, we are estimating, so we conclude that

$$\sum_{n=1}^{+\infty} |x_n|^r < +\infty,$$

and we have proved that $(x_n) \in \ell^r$.

Example 2.29 Define in \mathbb{R}^2 the function

$$\|x\| = \|(x_1, x_2)\| = \left(\sqrt{|x_1|} + \sqrt{|x_2|} \right)^2.$$

Is it a norm?

Sketch the set $\{(x_1, x_2) \mid \|(x_1, x_2)\| \leq 1\}$.

First note that $\|x\| = \|x\|_p$, where $p = \frac{1}{2} < 1$.

The first two conditions of a norm are trivially fulfilled, so we shall only consider the triangle inequality. We shall prove that it is *not* satisfied. It suffices to find two vectors x and y , for which the triangle inequality does not hold.

Choose $x = (1, 0)$ and $y = (0, 1)$. Then $\|x\| = \|y\| = 1$, and

$$\|x + y\| = \|(1, 1)\| = (\sqrt{1} + \sqrt{1})^2 = 4,$$

hence

$$\|x + y\| = 4 > 2 = \|x\| + \|y\|,$$

and the triangle inequality is not fulfilled, and $\|\cdot\|$ is not a norm.

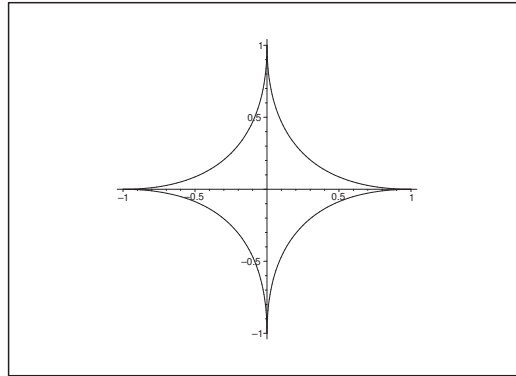

Figure 5: The unit “ball” corresponding to $\|\cdot\|$.

Remark 2.3 It is not hard to prove that *if* $\|\cdot\|$ is a norm, then the corresponding unit ball is convex. (However, not every convex set will induce a norm).

Since the set, which should be the unit ball clearly is *not* convex (cf. the figure), $\|\cdot\|$ is *not* a norm. \diamond

Remark 2.4 Even if $\|\cdot\|_{\frac{1}{2}}$ is not a norm in the usual sense, there exist some applications of it, e.g. in the theory of H^p spaces in Complex Function Theory, and the “norm” of such functions can nevertheless be given a reasonable interpretation. \diamond

Please click the advert

Turning a challenge into a learning curve. Just another day at the office for a high performer.

Accenture Boot Camp – your toughest test yet

Choose Accenture for a career where the variety of opportunities and challenges allows you to make a difference every day. A place where you can develop your potential and grow professionally, working alongside talented colleagues. The only place where you can learn from our unrivalled experience, while helping our global clients achieve high performance. If this is your idea of a typical working day, then Accenture is the place to be.

It all starts at Boot Camp. It's 48 hours that will stimulate your mind and enhance your career prospects. You'll spend time with other students, top Accenture Consultants and special guests. An inspirational two days

packed with intellectual challenges and activities designed to let you discover what it really means to be a high performer in business. We can't tell you everything about Boot Camp, but expect a fast-paced, exhilarating

and intense learning experience. It could be your toughest test yet, which is exactly what will make it your biggest opportunity.

Find out more and apply online.

Visit [accenture.com/bootcamp](https://www.accenture.com/bootcamp)

• Consulting • Technology • Outsourcing



3 Bounded operators

Example 3.1 Let T be a linear operator from a normed space V into a normed space W .

Show that the image $T(V)$ is a subspace of W .

Show that the kernel (or null-space) $\ker(T)$ is a subspace of V .

If T is bounded, is it true that $T(V)$ and/or $\ker(T)$ are closed?

1) Let $w_1, w_2 \in T(V) \subseteq W$, and let λ be a scalar. We shall prove that

$$w_1 + \lambda w_2 \in T(V).$$

Remark 3.1 It is here of paramount importance that the field of the scalars is the same both places. If e.g. $T : V \rightarrow W$ is given by

$$Tx = x + i \cdot 0,$$

where $V = (\mathbb{R}, +, \cdot, \|\cdot\|, \mathbb{R})$ and $W = (\mathbb{C}, +, \cdot, \|\cdot\|, \mathbb{C})$, then T is linear, and $T(V)$ is a subspace of the 2-dimensional space $(\mathbb{C}, +, \cdot, \|\cdot\|, \mathbb{R})$ over \mathbb{R} . It is, however, not a subspace of the 1-dimensional space $W = (\mathbb{C}, +, \cdot, \|\cdot\|, \mathbb{C})$ over \mathbb{C} , so the claim is not true in this case. \diamond

It follows from the assumption $w_1, w_2 \in T(V)$ that there exist v_1 and $v_2 \in V$, such that $w_1 = Tv_1$ and $w_2 = Tv_2$.

If we put $v = v_1 + \lambda v_2 \in V$, then

$$T(V) \ni Tv = T(v_1 + \lambda v_2) = Tv_1 + \lambda Tv_2 = w_1 + \lambda w_2.$$

2) Now $\ker(T) = \{v \in V \mid Tv = 0\}$, and T is linear. Hence, if $v_1, v_2 \in \ker(T)$, and λ is a scalar, then

$$T(v_1 + \lambda v_2) = Tv_1 + \lambda Tv_2 = 0 + \lambda \cdot 0 = 0,$$

thus $v_1 + \lambda v_2 \in \ker(T)$, and $\ker(T)$ is a subspace.

3) If T is bounded, then T is continuous. Now $\{0\} \subset W$ is closed, so $\ker(T) = T^{-1}(\{0\})$ is closed.

On the other hand, $T(V)$ need not be closed, which is demonstrated by the example below.

Choose $V = W = C^0([0, 1])$ with the norm $\|\cdot\|_\infty$, and let $T : V \rightarrow W$ be given by

$$Tf(t) = \int_0^t f(s) dx, \quad t \in [0, 1].$$

Then T is bounded,

$$|Tf(t)| = \left| \int_0^t f(s) ds \right| \leq \int_0^t |f(s)| ds \leq \int_0^1 |f(s)| ds \leq 1 \cdot \|f\|_{\text{inf ty}}, \quad t \in [0, 1],$$

hence

$$\|Tf\|_\infty \leq 1 \cdot \|f\|_\infty, \quad \|T\| \leq 1.$$

Furthermore,

$$T(V) = \{w \in C^1([0, 1]) \mid w(0) = 0\}$$

is dense in

$$\{w \in C^0([0, 1]) \mid w(0) = 0\} \subset W,$$

without being equal to it.

That $T(V)$ is dense, is seen in the following way: Every polynomial of constant term 0 lies in $T(V)$. The claim then follows by a suitable variant of Weierstraß's Approximation Theorem.

There exist of course C^0 -functions which are not of class C^1 , hence $T(V)$ is not equal to the smallest closed subspace

$$\{w \in C^0([0, 1]) \mid w(0) = 0\}$$

which contains $T(V)$ (because $T(V)$ is dense in this space).

Example 3.2 In the Banach space ℓ^p , $1 \leq p \leq \infty$, we have a sequence (x_n) converging to an element x , where

$$x_n = (x_{n1}, x_{n2}, \dots) \quad \text{and} \quad x = (x_1, x_2, \dots).$$

Show that if $x_n \rightarrow x$ in ℓ^p , then $x_{nk} \rightarrow x_k$ for all $k \in \mathbb{N}$.

If $x_{nk} \rightarrow x_k$ for all $k \in \mathbb{N}$, is it true that $x_n \rightarrow x$ in ℓ^p ?

Let $x_n \rightarrow x$ in ℓ^p , $1 \leq p < \infty$, thus $\|x - x_n\|_p \rightarrow 0$ for $n \rightarrow \infty$, i.e.

$$\sum_{k=1}^{\infty} |x_k - x_{nk}|^p = \|x - x_n\|_p^p \rightarrow 0 \quad \text{for } n \rightarrow \infty.$$

If $p = \infty$, then $x_n \rightarrow x$ in ℓ^∞ means that

$$\|x - x_n\|_\infty = \sup_k |x_k - x_{nk}| \rightarrow 0 \quad \text{for } n \rightarrow \infty.$$

In both cases we get for every fixed k that

$$|x_k - x_{nk}| \leq \|x - x_n\|_p \rightarrow 0 \quad \text{for } n \rightarrow \infty,$$

thus $x_{nk} \rightarrow x_k$ for $n \rightarrow \infty$, and the first claim is proved.

On the other hand, if $x_{nk} \rightarrow x_k$ for every fixed k , then we cannot conclude that $x_n \rightarrow x$ in ℓ^p . Just choose

$$x_n = (\delta_{nk}) = (0, \dots, 0, 1, 0, \dots)$$

with 1 on place number n , and 0 otherwise.

We have for this sequence that $x_{nk} \rightarrow 0$ for every fixed k , thus $x = 0$.

On the other hand,

$$\|x_n\|_p = \|x_n - 0\|_p = \left\{ \sum_{k=1}^{\infty} |\delta_{nk}|^p \right\}^{\frac{1}{p}} = 1 \quad \text{for } 1 \leq p < +\infty,$$

and

$$\|x_n\|_{\infty} = \|x_n - 0\|_{\infty} = 1,$$

so none of these sequences converges towards, i.e. the sequence does not converge in any ℓ^p , $1 \leq p \leq +\infty$.

Example 3.3 Let T be a linear mapping from \mathbb{R}^m to \mathbb{R}^n , both equipped with the 2-norm. Let (a_{ij}) denote a real $n \times m$ matrix corresponding to T . Show that T is a bounded linear operator with $\|T\|^2 \leq \sum_i \sum_j a_{ij}^2$.

We get (cf. EXAMPLE 1.23)

$$\begin{aligned} \|Tx\|_2^2 &= \left\| \left(\sum_{j=1}^m a_{ij}x_j \right)_{i \in \mathbb{N}} \right\|_2^2 = \sum_{i=1}^n \left\{ \sum_{j=1}^m a_{ij}x_j \right\}^2 = \sum_{i=1}^n \sum_{j=1}^m \sum_{k=1}^m a_{ij}x_j a_{ik}x_k \\ &= \sum_{i=1}^n \sum_{j=1}^m \sum_{k=1}^m (a_{ij}x_k) \cdot (a_{ik}x_j). \end{aligned}$$

Then note that

$$|a_{ij}x_k| \cdot |a_{ik}x_j| \leq \frac{1}{2} a_{ij}^2 x_k^2 + \frac{1}{2} a_{ik}^2 x_j^2.$$

By insertion of this inequality,

$$\begin{aligned} \|Tx\|_2^2 &= \sum_{i=1}^n \sum_{j=1}^m \sum_{k=1}^m (a_{ij}x_k) \cdot (a_{ik}x_j) \leq \frac{1}{2} \sum_{i=1}^n \sum_{j=1}^m \sum_{k=1}^m a_{ij}^2 x_k^2 + \frac{1}{2} \sum_{i=1}^n \sum_{j=1}^m \sum_{k=1}^m a_{ik}^2 x_j^2 \\ &= 2 \cdot \frac{1}{2} \sum_{i=1}^n \sum_{j=1}^m a_{ij}^2 \cdot \sum_{k=1}^m x_k^2 = \sum_{i=1}^n \sum_{j=1}^m a_{ij}^2 \cdot \|z\|_1^2. \end{aligned}$$

Since $\|T\|^2$ is the smallest constant, for which we have such an estimate, we have

$$\|T\|^2 \leq \sum_{i=1}^n \sum_{j=1}^m a_{ij}^2.$$

Example 3.4 Let T be a linear operator from a normed space V into a normed space W , and assume that V is finite dimensional. Show that T must be bounded.

The space V is finite dimensional, thus we can choose a basis e_1, \dots, e_n for V , where $\|e_k\|_V = 1$. Then for every $v \in V$,

$$\begin{aligned} \|Tv\|_W &= \left\| T \left(\sum_{j=1}^n \lambda_j e_j \right) \right\|_W = \left\| \sum_{j=1}^n \lambda_j T e_j \right\|_W \leq \sum_{j=1}^n |\lambda_j| \cdot \|T e_j\|_W \\ &\leq \max \{ \|T e_j\|_W \mid j = 1, \dots, n \} \cdot \sum_{j=1}^n |\lambda_j|. \end{aligned}$$

If we can prove that there exists a constant $c > 0$, such that

$$(12) \quad \sum_{j=1}^n |\lambda_j| \leq c \left\| \sum_{j=1}^n \lambda_j e_j \right\|_V \quad \text{for every } \lambda_1, \dots, \lambda_n,$$

then

$$\|Tv\|_W \leq c \cdot \max_j \|T e_j\|_W \cdot \|v\|_V,$$

which shows that T is bounded

$$\|T\| \leq c \cdot \max_{j=1, \dots, n} \|T e_j\|_W.$$

We shall therefore only prove (12).

Please click the advert





it's an **interesting** world

Get under the skin of it.

Graduate opportunities
Cheltenham | £24,945 + benefits

One of the UK's intelligence services, GCHQ's role is two-fold: to gather and analyse intelligence which helps shape Britain's response to global events, and, to provide technical advice for the protection of Government communication and information systems. In doing so, our specialists – in IT, internet, engineering, languages, information assurance, mathematics and intelligence – get well beneath the surface of global affairs. If you thought the world was an interesting place, you really ought to explore our world of work.

www.careersinbritishintelligence.co.uk

Applicants must be British citizens. GCHQ values diversity and welcomes applicants from all sections of the community. We want our workforce to reflect the diversity of our work.







INDIRECT PROOF. Assume that (12) does *not* hold, i.e. assume that

$$(13) \quad \forall N \in \mathbb{N} \exists \lambda_{N,1}, \dots, \lambda_{N,n} : \sum_{j=1}^n |\lambda_{N,j}| > N \left\| \sum_{j=1}^n \lambda_{N,j} e_j \right\|_V.$$

Due to the homogeneity we may assume that $\lambda_{N,j}$ is chosen, such that

$$\sum_{j=1}^n |\lambda_{N,j}| = 1.$$

Then it follows from (13) that $\|v_N\|_V \leq \frac{1}{N}$, hence

$$v_N = \sum_{j=1}^n \lambda_{N,j} e_j \rightarrow 0 \quad \text{for } N \rightarrow \infty.$$

Now, e_1, \dots, e_n is a basis for V , hence $\lambda_{N,j} \rightarrow 0$ for $N \rightarrow \infty$ for every $j = 1, \dots, n$. In particular, there is an $N_0 \in \mathbb{N}$, such that for every $N \geq N_0$ we have $|\lambda_{N,j}| < \frac{1}{2n}$. This gives us the following *contradiction*

$$1 = \sum_{j=1}^n |\lambda_{N,j}| < \sum_{j=1}^n \frac{1}{2n} = \frac{1}{2}.$$

We have now proved that (13) does *not* hold, hence (12) holds instead, and as proved previously (12) implies that T is bounded, and the claim is proved.

Example 3.5 Let T be a linear operator from a finite dimensional vector space into itself. Show that T is injective if and only if T is surjective.

Let $T : V \rightarrow V$ be linear, where $\dim V = n$. Let e_1, \dots, e_n form a basis. Now, T is linear, so T is injective, if and only if $Tu = Tv$, i.e. $T(u-v) = 0$ implies that $u = v$, or put in another way, $u-v = 0$. Thus T is injective, if and only if

$$(14) \quad Tv = 0 \implies v = 0.$$

Now assume that T is injective. We shall prove that $Te_1, \dots, Te_n \in V$ are linearly independent.

Assume that $\lambda_1 Te_1 + \dots + \lambda_n Te_n = 0$. Then by the linearity,

$$0 = \lambda_1 Te_1 + \dots + \lambda_n Te_n = T(\lambda_1 e_1 + \dots + \lambda_n e_n),$$

and we conclude using (14) that

$$\lambda_1 e_1 + \dots + \lambda_n e_n = 0.$$

Since e_1, \dots, e_n is a basis for V , we must have $\lambda_1 = \dots = \lambda_n = 0$, and it follows that Te_1, \dots, Te_n are n linearly independent vectors in the image $T(V)$. Then

$$n \geq \dim T(V) \geq n, \quad \text{thus} \quad \dim T(V) = n,$$

hence $T(V) = V$, and we have proved that T is surjective.

Assume conversely that T is surjective. To the basis formed by $e_1, \dots, e_n \in V$ corresponds the vectors $f_1, \dots, f_n \in V$, where

$$Tf_1 = e_1, \quad \dots, \quad Tf_n = e_n.$$

If $\lambda_1 f_1 + \dots + \lambda_n f_n = 0$, then we conclude that

$$0 = T(\lambda_1 f_1 + \dots + \lambda_n f_n) = \lambda_1 Tf_1 + \dots + \lambda_n Tf_n = \lambda_1 e_1 + \dots + \lambda_n e_n.$$

Using again that e_1, \dots, e_n form a basis for V , we infer that $\lambda_1 = \dots = \lambda_n = 0$, which again implies that f_1, \dots, f_n form a basis for V .

If $v = \lambda_1 f_1 + \dots + \lambda_n f_n$ satisfies $Tv = 0$, then

$$0 = Tv = T(\lambda_1 f_1 + \dots + \lambda_n f_n) = \lambda_1 Tf_1 + \dots + \lambda_n Tf_n = \lambda_1 e_1 + \dots + \lambda_n e_n,$$

and we infer again that $\lambda_1 = \dots = \lambda_n = 0$, hence $v = 0$, and (14) is fulfilled, so T is injective.

Example 3.6 Let T be the linear mapping from $C^\infty(\mathbb{R})$ into itself given by $Tf = f'$. Show that T is surjective? Is T injective?

Let $f \in C^\infty(\mathbb{R})$. Define $g \in C^\infty(\mathbb{R})$ by

$$g(t) = \int_0^t f(s) ds, \quad t \in \mathbb{R}.$$

Clearly, $Tg = g$, so $T(V) = C^\infty(\mathbb{R})$, and T is surjective.

Define instead

$$g_1(t) = 1 + \int_0^t f(s) ds = 1 + g(t) \in C^\infty(\mathbb{R}).$$

Then

$$Tg_1 = f = Tg,$$

and since $g_1 \neq g$, it follows that T is not injective.

Example 3.7 Let $I = [a, b]$ be a bounded interval and consider the linear mapping T from $C([a, b])$ into itself, given by

$$Tf(t) = \int_a^t f(s) ds.$$

We assume that $C([a, b])$ is equipped with the sup-norm.

Show that T is bounded and find $\|T\|$.

Show that T is injective and find $T^{-1} : T(C([a, b])) \rightarrow C([a, b])$.

Is T^{-1} bounded?

When

$$Tf(t) = \int_a^t f(s) ds \quad \text{for } t \in [a, b],$$

then

$$|Tf(t)| = \left| \int_a^t f(s) ds \right| \leq \int_a^t |f(s)| ds \leq \|f\|_\infty \int_a^t ds = (t-a)\|f\|_\infty \leq (b-a) \cdot \|f\|_\infty,$$

thus

$$\|Tf\|_\infty \leq (b-a) \cdot \|f\|_\infty,$$

proving that T is bounded and $\|T\| \leq b-a$.

Choose $f(t) = 1$ for every $t \in [a, b]$. Then $\|f\|_\infty = 1$, and

$$Tf(t) = \int_a^t ds = t-a \quad \text{for } t \in [a, b],$$

hence

$$\|Tf\|_\infty = \sup_{t \in [a, b]} (t-a) = b-a,$$

and we conclude that $\|T\| \geq b-a$, whence by the previously proved result, $\|T\| = b-a$.

Assume that

$$Tf(t) = \int_a^t f(s) ds \equiv 0.$$

Since $f \in C([a, b])$, we have $Tf \in C^1([a, b])$ with

$$\frac{d}{dt} Tf(t) = f(t) \equiv 0,$$

which shows that $f \equiv 0$, so T is injective.

It follows from the above that $T(C([a, b])) \subseteq C^1([a, b])$. We get from $Tf(a) = 0$ that even

$$T(C([a, b])) \subseteq \{g \in C^1([a, b]) \mid g(a) = 0\}.$$

Conversely, if $g \in C^1([a, b])$ and $g(a) = 0$, then $f = g' \in C([a, b])$, and $Tf = g$, and the image becomes

$$T(C([a, b])) = \{g \in C^1([a, b]) \mid g(a) = 0\}.$$

Finally, it is immediately seen that

$$T^{-1} : T(C([a, b])) \rightarrow C([a, b])$$

is given by $T^{-1}g = g'$.

The operator T^{-1} is not bounded. We have e.g. that $(t - a)^n \in T(C([a, b]))$, and

$$\|(t - a)^n\|_\infty = \sup_{t \in [a, b]} |(t - a)^n| = (b - a)^n.$$

It follows from $T^{-1}(t - a)^n = n(t - a)^{n-1}$ that

$$\|T^{-1}(t - a)^n\|_\infty = n(b - a)^{n-1} = \frac{n}{b - a} \|(t - a)^n\|_\infty,$$

proving that there is no constant $c > 0$, such that

$$\|T^{-1}f\|_\infty \leq c \|f\|_\infty, \quad \text{for all } f \in T(C([a, b])),$$

and T is not bounded.

Please click the advert



Brain power

By 2020, wind could provide one-tenth of our planet's electricity needs. Already today, SKF's innovative know-how is crucial to running a large proportion of the world's wind turbines.

Up to 25 % of the generating costs relate to maintenance. These can be reduced dramatically thanks to our systems for on-line condition monitoring and automatic lubrication. We help make it more economical to create cleaner, cheaper energy out of thin air.

By sharing our experience, expertise, and creativity, industries can boost performance beyond expectations. Therefore we need the best employees who can meet this challenge!

The Power of Knowledge Engineering

Plug into The Power of Knowledge Engineering.
Visit us at www.skf.com/knowledge

SKF

Example 3.8 Let T be a bounded linear operator from a normed vector space V into a normed vector space W , and assume that T is surjective. Assume that there is a $c > 0$, such that

$$\|Tx\| \geq c\|x\| \quad \text{for all } x \in V.$$

show that T^{-1} exists and that $T^{-1} \in B(W, V)$.

We require that T^{-1} exists, so we shall first prove that T is injective, i.e. if $Tx = Ty$, then $x = y$.

The mapping T is linear, so this is equivalent with that $T(x - y) = 0$ implies that $x - y = 0$, or by a slight change of notation:

Assume that $Tx = 0$. Prove that $x = 0$.

When $Tx = 0$, then it follows from the assumption that

$$0 \leq \|x\| \leq \frac{1}{c} \|Tx\| = 0, \quad \text{thus } \|x\| = 0, \text{ hence } x = 0,$$

and the claim is proved.

We have proved that T is injective, thus T^{-1} exists. Now $T(V) = W$, so $T^{-1} : W \rightarrow V$, and T^{-1} is defined on all of W . It remains only to be proved that T^{-1} is bounded.

Let $y \in W$. Then $x = T^{-1}y$ is defined. It follows from the assumption that

$$\|T^{-1}y\| = \|x\| \leq \frac{1}{c} \|Tx\| = \frac{1}{c} \|T(T^{-1}y)\| = \frac{1}{c} \|y\|,$$

which shows that T^{-1} is bounded, $\|T^{-1}\| \leq \frac{1}{c}$, and it follows that $T^{-1} \in B(W, V)$.

Example 3.9 Let V and W be two normed spaces. Prove that $B(V, W)$ is a normed vector space and that $B(V, W)$ is a Banach space, if W is a Banach space.

It is well-known that $B(V, W)$ is a vector space.

Define $\|T\|$ by

$$\|T\| = \sup\{\|Tx\|_W \mid \|x\|_V \leq 1\}.$$

Then clearly, $\|T\| \geq 0$. If $T \neq 0$, then there exists an $x \in V$, such that $Tx \neq 0$, and we conclude that $\|T\| = 0$, if and only if $T = 0$.

Furthermore,

$$\|\alpha T\| = \sup\{\|\alpha Tx\|_W \mid \|x\|_V \leq 1\} = |\alpha| \cdot \sup\{\|Tx\|_W \mid \|x\|_V \leq 1\} = |\alpha| \cdot \|T\|.$$

Finally,

$$\begin{aligned} \|T_1 + T_2\| &= \sup\{\|(T_1 + T_2)x\|_W \mid \|x\|_V \leq 1\} \leq \sup\{\|T_1x\|_W + \|T_2x\|_W \mid \|x\|_V \leq 1\} \\ &\leq \sup\{\|T_1x\|_W \mid \|x\|_V \leq 1\} + \sup\{\|T_2x\|_W \mid \|x\|_V \leq 1\} = \|T_1\| + \|T_2\|, \end{aligned}$$

and we have proved that $\|\cdot\|$ is a norm on $B(V, W)$, and $B(V, W)$ is a normed vector space.

We now assume that W is a Banach space, thus every Cauchy sequence on W is convergent. We shall prove that $B(V, W)$ becomes a Banach space with the norm introduced above. Let (T_n) be a Cauchy sequence on $B(V, W)$, i.e.

$$\forall \varepsilon > 0 \exists N \in \mathbb{N} \forall m, n \geq N : \|T_m - T_n\| < \varepsilon.$$

Then it follows from the definition that

$$\|T_m - T_n\| = \sup\{\|(T_m - T_n)x\|_W \mid \|x\|_V \leq 1\} = \sup\{\|T_m - T_n\|_W \mid \|x\|_V \leq 1\} < \varepsilon.$$

In particular, we have for every $x \in V$, for which $\|x\|_V \leq 1$ that

$$\forall \varepsilon > 0 \exists N \in \mathbb{N} \forall m, n \geq N : \|T_mx - T_nx\|_W < \varepsilon,$$

which is the condition for (T_nx) being a Cauchy sequence on W . We assumed that W was a Banach space, so it is complete. This implies that (T_nx) is convergent, and it follows that $(T_n(\lambda x)) = (\lambda T_nx)$ is also convergent in W for every λ , and the condition $\|x\|_V \leq 1$ has become superfluous.

Define an operator $T : V \rightarrow W$ by

$$Tx = \lim_{n \rightarrow +\infty} T_nx, \quad x \in V.$$

Then

$$T(x + \lambda y) = \lim_{n \rightarrow +\infty} T_n(x + \lambda y) = \lim_{n \rightarrow +\infty} \{T_nx + \lambda T_ny\} = \lim_{n \rightarrow +\infty} T_nx + \lambda \lim_{n \rightarrow +\infty} T_ny = Tx + \lambda Ty,$$

which shows that T is linear.

It remains to be proved that $T \in B(V, W)$, i.e. that T is bounded. If $x \in V$ with $\|x\|_V \leq 1$, then

$$\|Tx\| = \left\| \lim_{n \rightarrow +\infty} T_nx \right\| \leq \sup_{n \in \mathbb{N}} \|T_nx\| \leq \sup_{n \in \mathbb{N}} \|T_n\|.$$

Since (T_n) is a Cauchy sequence, we have $\sup_{n \in \mathbb{N}} \|T_n\| < +\infty$, and we conclude that $T \in B(V, W)$. Thus we have proved that the Cauchy sequence $(T_n) \subseteq B(V, W)$ converges towards $T \in B(V, W)$, and we have proved that $B(V, W)$ is a Banach space.

Example 3.10 Let $S, T \in B(V, V)$. Prove that the composite mapping ST (defined by $(ST)x = S(Tx)$ for $x \in V$) belongs to $B(V, V)$, and that

$$\|ST\| \leq \|S\| \cdot \|T\|.$$

When $S, T \in B(V, V)$, the composition ST is defined (and linear) on all of V . We shall only prove that ST is bounded. Now, for every $x \in V$,

$$\|(ST)x\|_V = \|S(Tx)\|_V \leq \|S\| \cdot \|Tx\|_V \leq \|S\| \cdot \|T\| \cdot \|x\|_V,$$

so

$$\|ST\| = \sup\{\|(ST)x\|_V \mid \|x\|_V \leq 1\} \leq \sup\{\|S\| \cdot \|T\| \cdot \|x\|_V \mid \|x\|_V \leq 1\} = \|S\| \cdot \|T\|.$$

Example 3.11 Let V be a Banach space and let $T \in B(V)$ be such that T^{-1} exists and belongs to $B(V)$.

Show that if $\|T\|$ and $\|T^{-1}\| \leq 1$, then

$$\|T\| = \|T^{-1}\| = 1,$$

and $\|Tf\| = \|f\|$ for all $f \in V$.

It follows from the assumptions that T is bijective,

$$(15) \quad Tf = g, \quad T^{-1}g = f.$$

We first prove that

$$\|Tf\| = \|f\| \quad \text{for every } f \in V.$$

This follows from

$$\|Tf\| \leq \|T\| \cdot \|f\| = \|f\| = \|T^{-1}f\| \leq \|T^{-1}\| \cdot \|g\| = \|g\| = \|Tf\|.$$

Hence we must have equality everywhere, and in particular,

$$\|Tf\| = \|f\| \quad \text{for all } f \in V,$$

and

$$\|T^{-1}g\| = \|g\| \quad \text{for all } g \in V.$$

Finally, we get

$$\|T\| = \sum\{\|Tf\| \mid \|f\| = 1\} = \sup\{\|f\| \mid \|f\| = 1\} = 1,$$

and

$$\|T^{-1}\| = \sup\{\|T^{-1}g\| \mid \|g\| = 1\} = \sup\{\|g\| \mid \|g\| = 1\} = 1.$$

Example 3.12 Let H denote a Hilbert space and let $T \in B(H)$ and assume that there is a positive c such that

$$|(Tx, x)| \geq c \|x\|^2 \quad \text{for all } x \in H.$$

Show that T^{-1} exists and belongs to $B(H)$.

Assume that $Tx = 0$. Then

$$0 = |(Tx, x)| \geq c \|x\|^2 \geq 0,$$

from which we conclude that $x = 0$, and we have proved that T is injective, so T^{-1} exists.

If $x = T^{-1}y$ for some $y \in H$, then it follows from the estimate

$$c \|x\|^2 = c \|T^{-1}y\|^2 \leq |(y, T^{-1}y)| \leq \|y\| \cdot \|T^{-1}y\|,$$

that $\|T^{-1}\| \leq \frac{1}{c}$, so T^{-1} is bounded on the image $T(H)$.

It remains to prove that the image $T(H)$ is all of H . Let $x \perp T(H)$. Then we get again that

$$0 = |(Tx, x)| \geq c \|x\|^2,$$

which proves that $x = 0$ is the only vector, which is perpendicular to the image, so $\overline{T(H)} = H$. Since T^{-1} is bounded, it has a continuous extension to $\overline{T(H)} = H$, and it follows that $T^{-1} \in B(H)$.

Trust and responsibility

NNE and Pharmaplan have joined forces to create NNE Pharmaplan, the world's leading engineering and consultancy company focused entirely on the pharma and biotech industries.

Inés Aréizaga Esteva (Spain), 25 years old
Education: Chemical Engineer

– You have to be proactive and open-minded as a newcomer and make it clear to your colleagues what you are able to cope. The pharmaceutical field is new to me. But busy as they are, most of my colleagues find the time to teach me, and they also trust me. Even though it was a bit hard at first, I can feel over time that I am beginning to be taken seriously and that my contribution is appreciated.

Please click the advert



NNE Pharmaplan is the world's leading engineering and consultancy company focused entirely on the pharma and biotech industries. We employ more than 1500 people worldwide and offer global reach and local knowledge along with our all-encompassing list of services.
nnepharmaplan.com

nne pharmaplan®

Example 3.13 Let $p > 1$ and let $f(x, t) \geq 0$ be a (measurable) function on \mathbb{R}^2 such that

$$g(t) = \left\{ \int_{\mathbb{R}} f(x, t) dx \right\}^{p-1}$$

exists.

1) Put $q = \frac{p}{p-1}$ and show that

$$\left\| \int_{\mathbb{R}} f(x, \cdot) dx \right\|_p^p \leq \|g\|_q \int_{\mathbb{R}} \|f(x, \cdot)\|_p dx.$$

2) Let $f(x, t)$ be a (measurable) function on \mathbb{R}^2 such that the function

$$x \mapsto \|f(x, \cdot)\|_p$$

belongs to $L^1(\mathbb{R})$. Use question 1 to show the inequality

$$\left\| \int_{\mathbb{R}} f(x, \cdot) dx \right\|_p \leq \int_{\mathbb{R}} \|f(x, \cdot)\|_p dx,$$

first for $p > 1$, and then for $p = 1$.

3) Let $g \in L^p(\mathbb{R})$ and $h \in L^1(\mathbb{R})$. We define the convolution $g \star h$ by

$$g \star h(t) = \int_{\mathbb{R}} g(t-x) h(x) dx.$$

Show that convolution with an $L^1(\mathbb{R})$ -function is a linear and bounded mapping from $L^p(\mathbb{R})$ into $L^p(\mathbb{R})$ for any $p > 1$.

1) We get

$$\begin{aligned} \left\| \int_{\mathbb{R}} f(x, \cdot) dx \right\|_p^p &= \int_{\mathbb{R}} \left\{ \int_{\mathbb{R}} f(x, t) dx \right\}^p dt = \int_{\mathbb{R}} g(t) \left\{ \int_{\mathbb{R}} f(x, t) dx \right\} dt \\ &= \int_{\mathbb{R}} \left\{ \int_{\mathbb{R}} g(t) \cdot f(x, t) dt \right\} dx \leq \int_{\mathbb{R}} \|g\|_q \|f(x, \cdot)\|_p dx \\ &= \|g\|_q \int_{\mathbb{R}} \|f(x, \cdot)\|_p dx. \end{aligned}$$

2) We may of course assume that $f(x, t) \geq 0$, because we can in general replace f by $|f|$, which gives a more “narrow” estimate. Then we can use the result from 1.

Let $p > 1$. Then

$$\begin{aligned} \|g\|_q &= \left\{ \int_{\mathbb{R}} \left(\int_{\mathbb{R}} f(x, t) dx \right)^{(p-1) \cdot \frac{p}{p-1}} dt \right\}^{\frac{p-1}{p}} = \left(\int_{\mathbb{R}} \left(\int_{\mathbb{R}} f(x, t) dx \right)^p dt \right)^{\frac{1}{p}} \\ &= \left\| \int_{\mathbb{R}} f(x, \cdot) dx \right\|_p^{p-1}, \end{aligned}$$

which inserted into the result of 1) gives

$$\left\| \int_{\mathbb{R}} f(x, \cdot) dx \right\|_p^p \leq \left\| \int_{\mathbb{R}} f(x, \cdot) dx \right\|_o^{p-1} \cdot \int_{\mathbb{R}} \|f(x, \cdot)\|_p dx.$$

Since $p > 1$, this is reduced to

$$\left\| \int_{\mathbb{R}} f(x, \cdot) dx \right\|_p \leq \int_{\mathbb{R}} \|f(x, \cdot)\|_p dx.$$

When $p = 1$, then we get instead by interchanging the order of integration

$$\left\| \int_{\mathbb{R}} f(x, \cdot) dx \right\|_1 = \int_{\mathbb{R}} \left\{ \int_{\mathbb{R}} f(x, t) dx \right\} dt = \int_{\mathbb{R}} \left\{ \int_{\mathbb{R}} f(x, t) dt \right\} dx = \int_{\mathbb{R}} \|f(x, \cdot)\|_1 dt.$$

For a general f we get

$$\left\| \int_{\mathbb{R}} f(x, \cdot) dx \right\|_1 \leq \left\| \int_{\mathbb{R}} |f(x, \cdot)| dx \right\|_p \leq \int_{\mathbb{R}} \|f(x, \cdot)\|_p dx,$$

because $\| |f(x, \cdot)| \|_p = \|f(x, \cdot)\|_p$.

3) Given $h \in L^1(\mathbb{R})$ - Define an operator T by

$$Tg(x) = g \star h(x),$$

for the $g \in L^p(\mathbb{R})$, $p > 1$, for which this expression makes sense. Then clearly, T is linear.

Let $g \in L^p(\mathbb{R})$. Using 2) above we get the following estimate, where we allow ourselves to write $\|g \star h\|$ before we have proved that it makes sense,

$$\begin{aligned} \|Tg\|_p &= \|g \star h\|_p = \left\| \int_{\mathbb{R}} g(\star - x) h(x) dx \right\|_p \\ &\leq \int_{\mathbb{R}} \|g(\star - x)\|_p \cdot h(x) dx = \|g\|_p \cdot \|h\|_1 < \infty. \end{aligned}$$

This estimate shows that $g \star h \in L^p(\mathbb{R})$ is defined and that the mapping T is bounded of norm $\|T\| \leq \|h\|_1$.

,

Index

- approximation of zeros, 25
 Banach space, 43, 60, 88
 Banach's Fixpoint Theorem, 25, 33
 Bernstein polynomial, 4
 Bohnenblust-Bunjakovski-Cauchy-Schwarz-Sobčyk's inequality, 71
 bounded operator, 80
 Cauchy-Schwarz inequality, 20
 Cauchy-Schwarz's inequality, 71
 compact set, 53, 61
 complete metric space, 17
 continuous mapping, 9
 contraction, 24, 28, 30, 31, 36
 convergent series, 64
 convolution, 92
 diameter, 11
 discrete metric space, 15
 dual space, 65
 equivalent norms, 52
 even function, 46
 fixpoint, 24
 Gamma function, 73
 generalized Hölder's inequality, 73
 Hölder's inequality, 71, 78
 integral equation, 36
 iteration, 25
 jump, 70
 kernel, 80
 Lebesgue integral, 68
 linear functional, 59
 Lipschitz condition, 28
 Mean Value Theorem, 28
 metric on product space, 14
 metric space, 4, 7, 11
 Neumann series, 41, 42
 Newton's iteration formula, 28
 norm, 47
 normed space, 47
 null-space, 80
 odd function, 46
 open ball, 7
 open ball topology, 17
 p-norm, 49
 polynomial, 43, 45
 product space, 60
 regular matrix, 45
 Riesz's lemma, 55, 57
 sequential compactness, 61
 space of bounded sequences, 22
 space of convergent sequences, 22
 Stirling's formula, 75
 sup-norm, 47
 symmetric matrix, 45
 topological space, 4, 7
 topology, 7
 topology of open balls, 17
 uniform convergence, 4
 unit ball, 57
 vector space, 43
 vector space of bounded sequences, 57
 Volterra integral equation, 36
 weak contraction, 24
 Weierstraß's Approximation Theorem, 47, 81
 Weierstraß's approximation theorem, 4, 6